

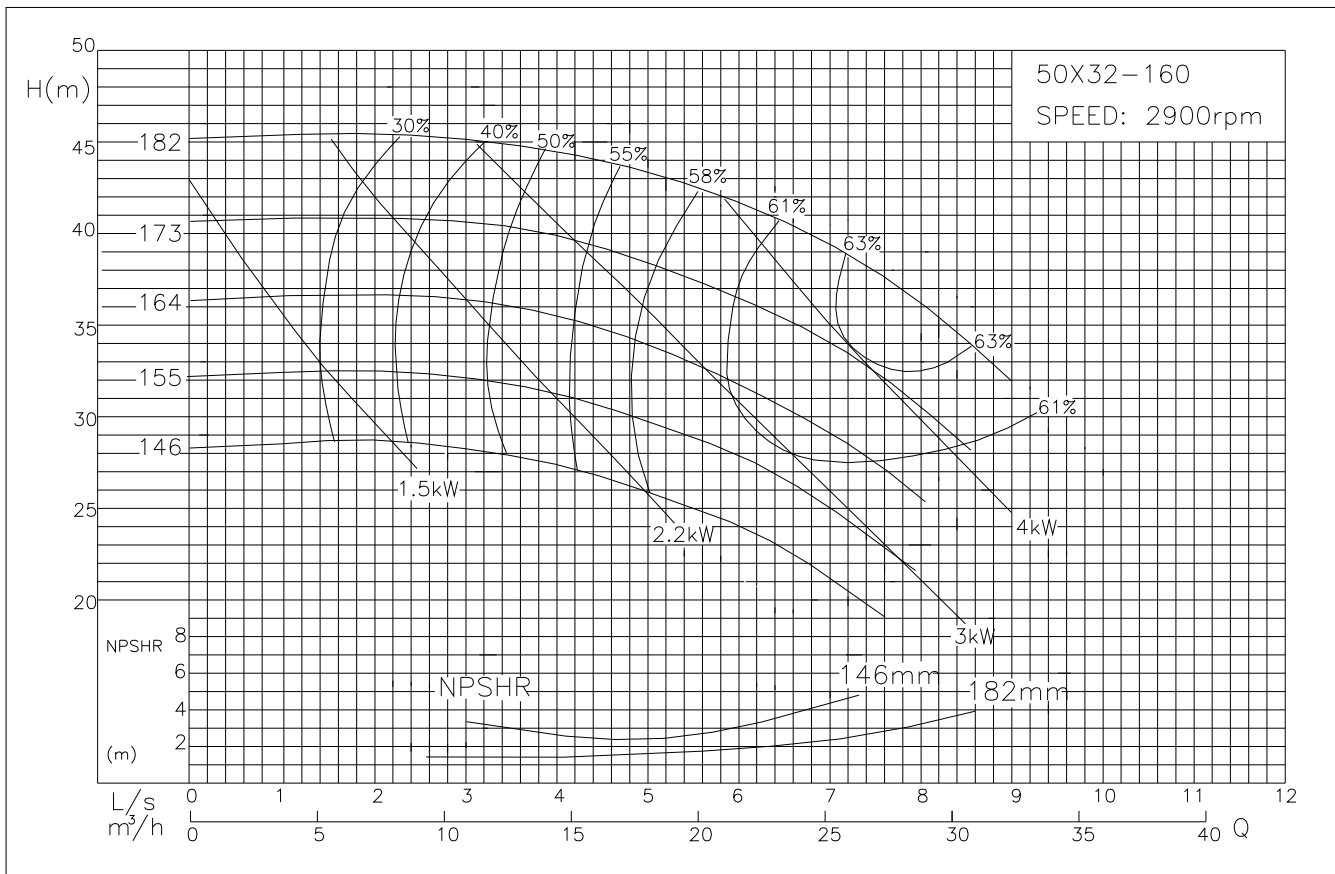

Performance Curves

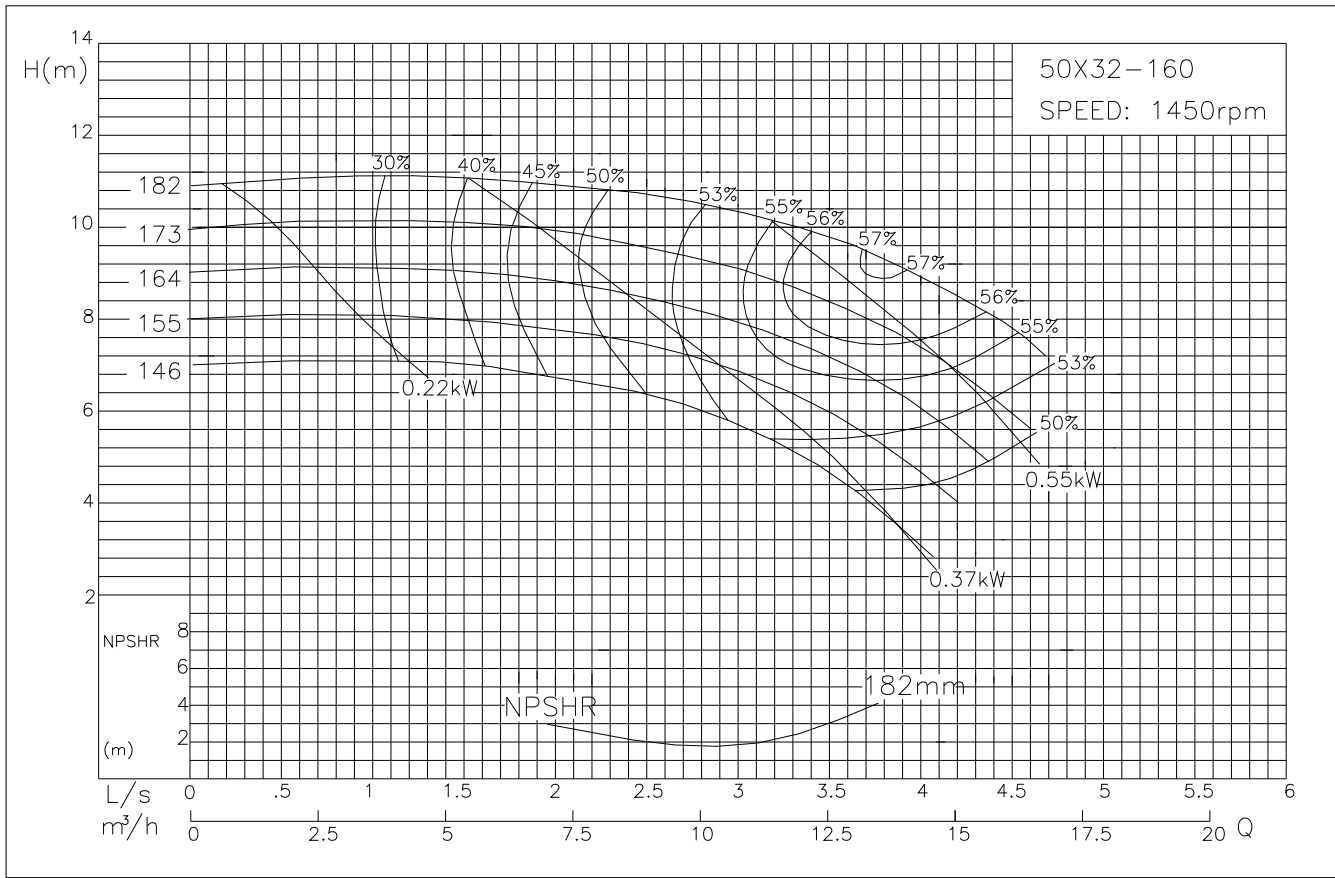



Performance Curves

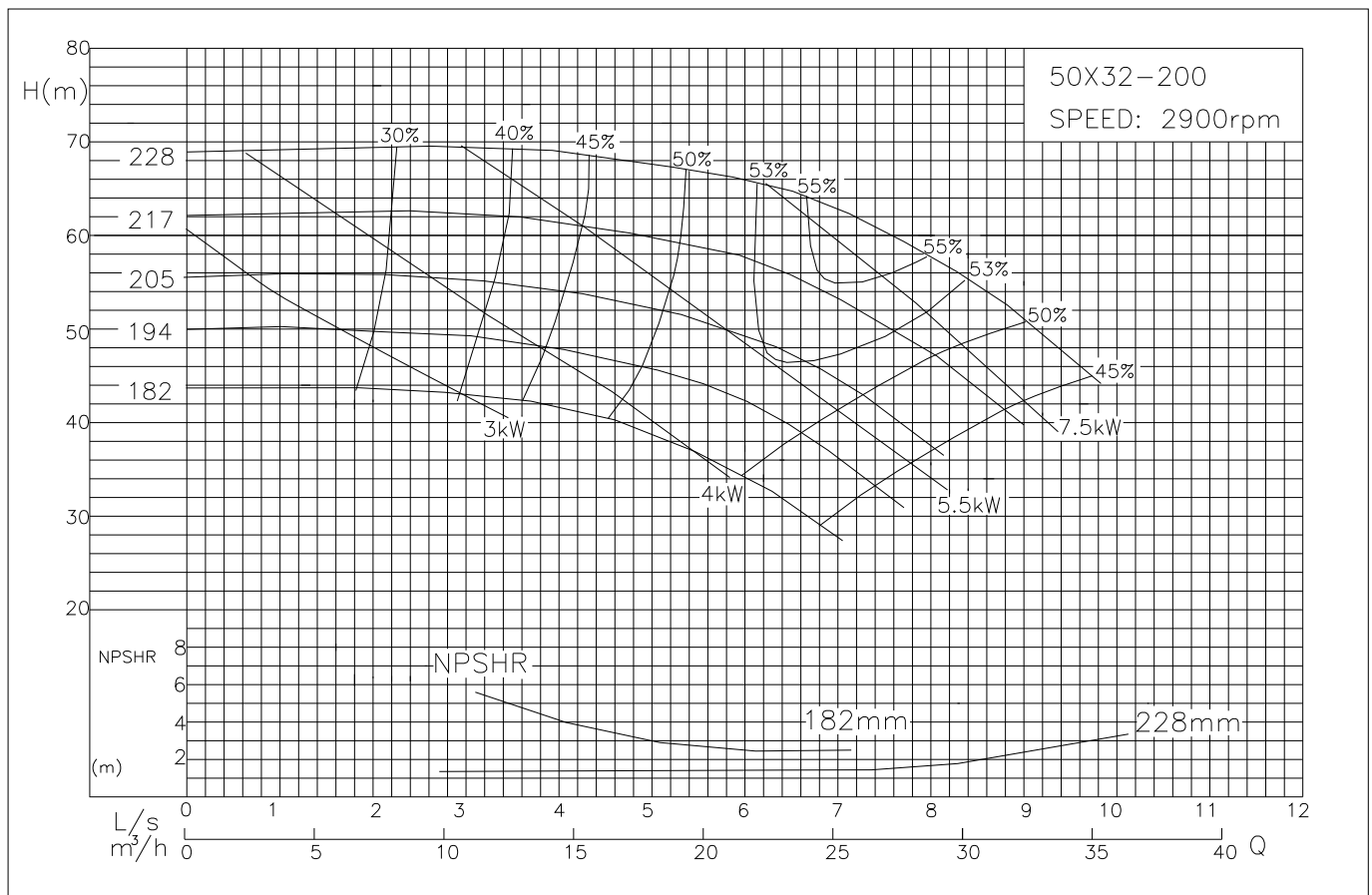
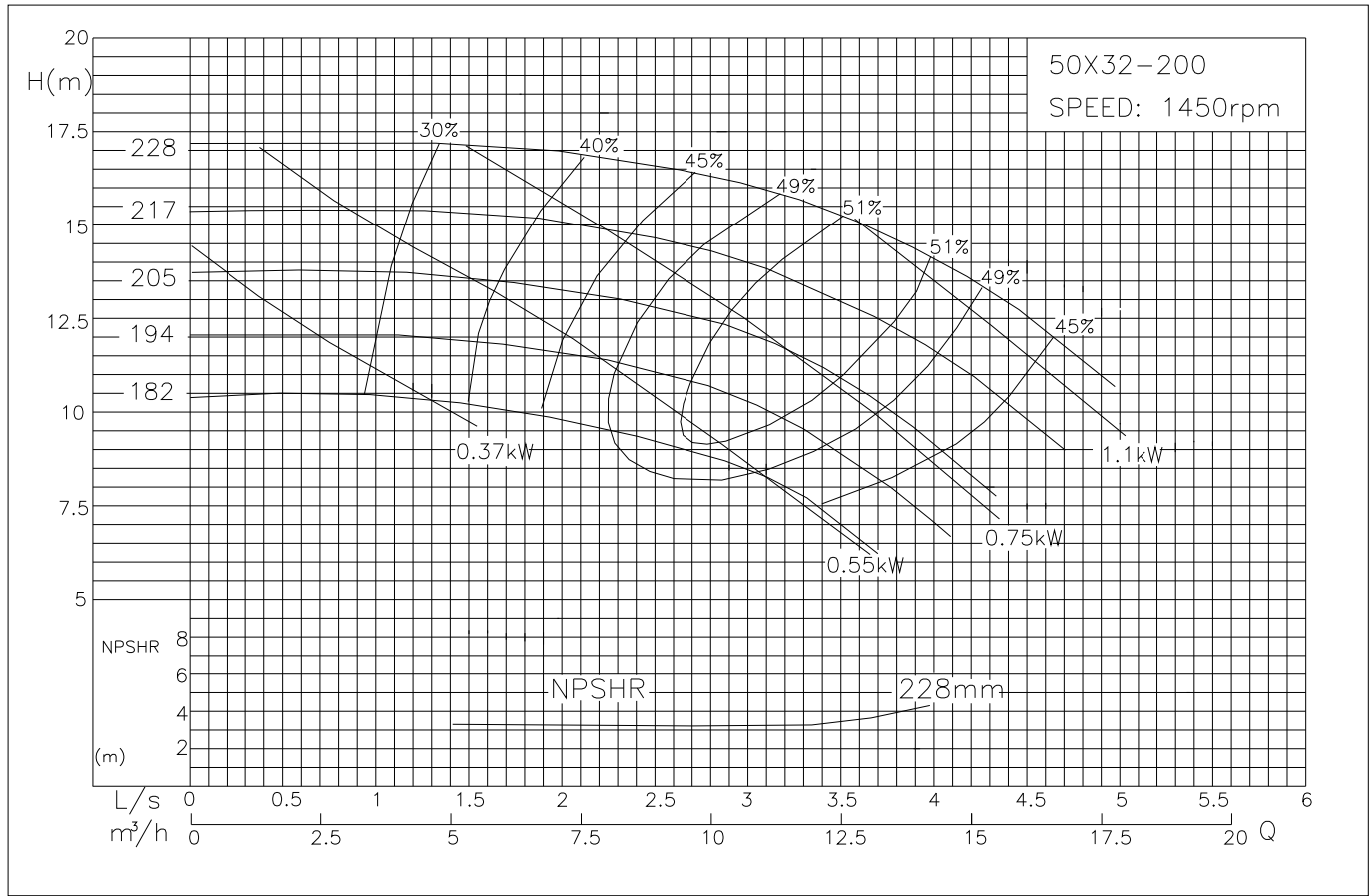



Performance Curves

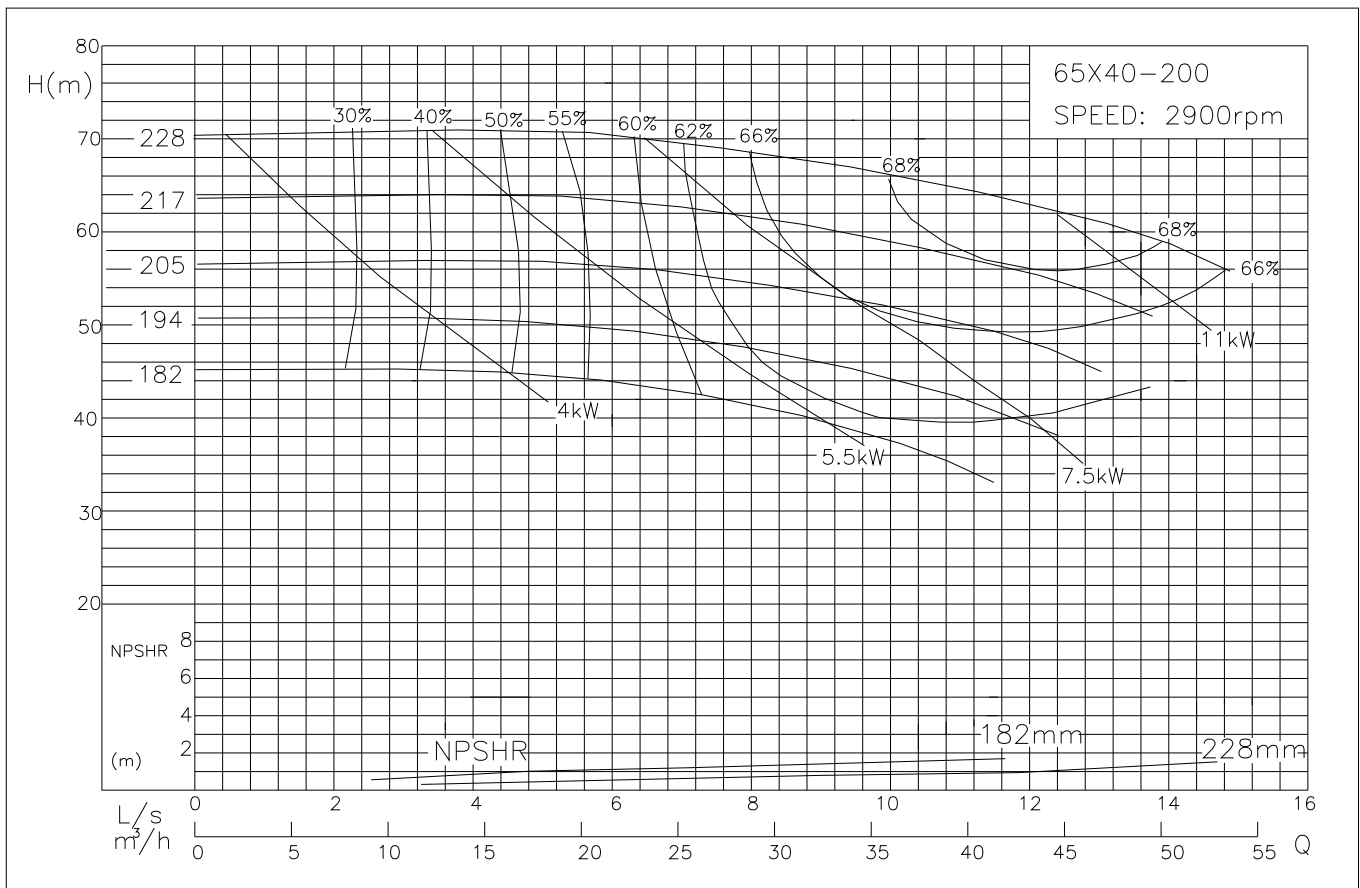
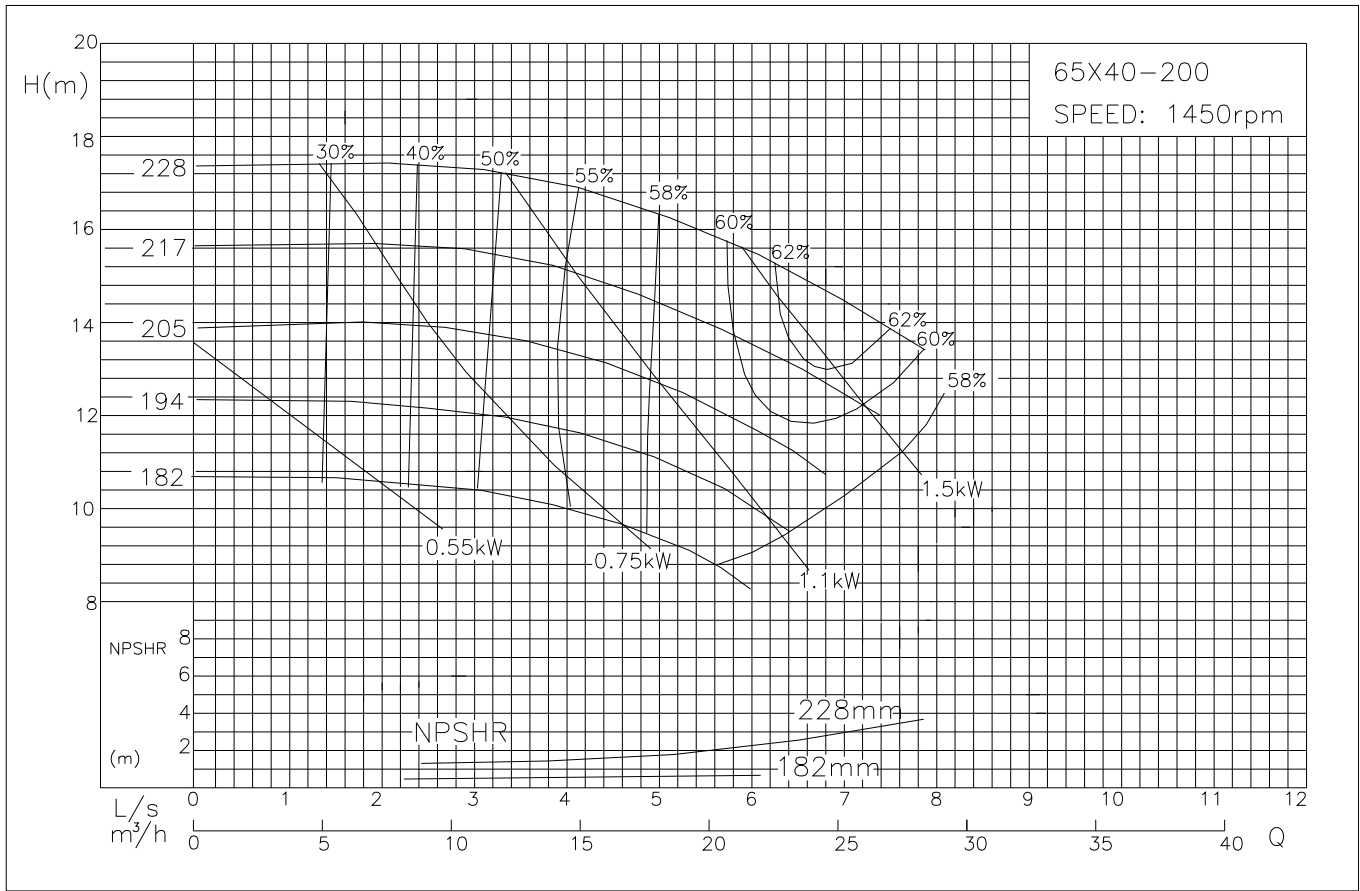



Performance Curves

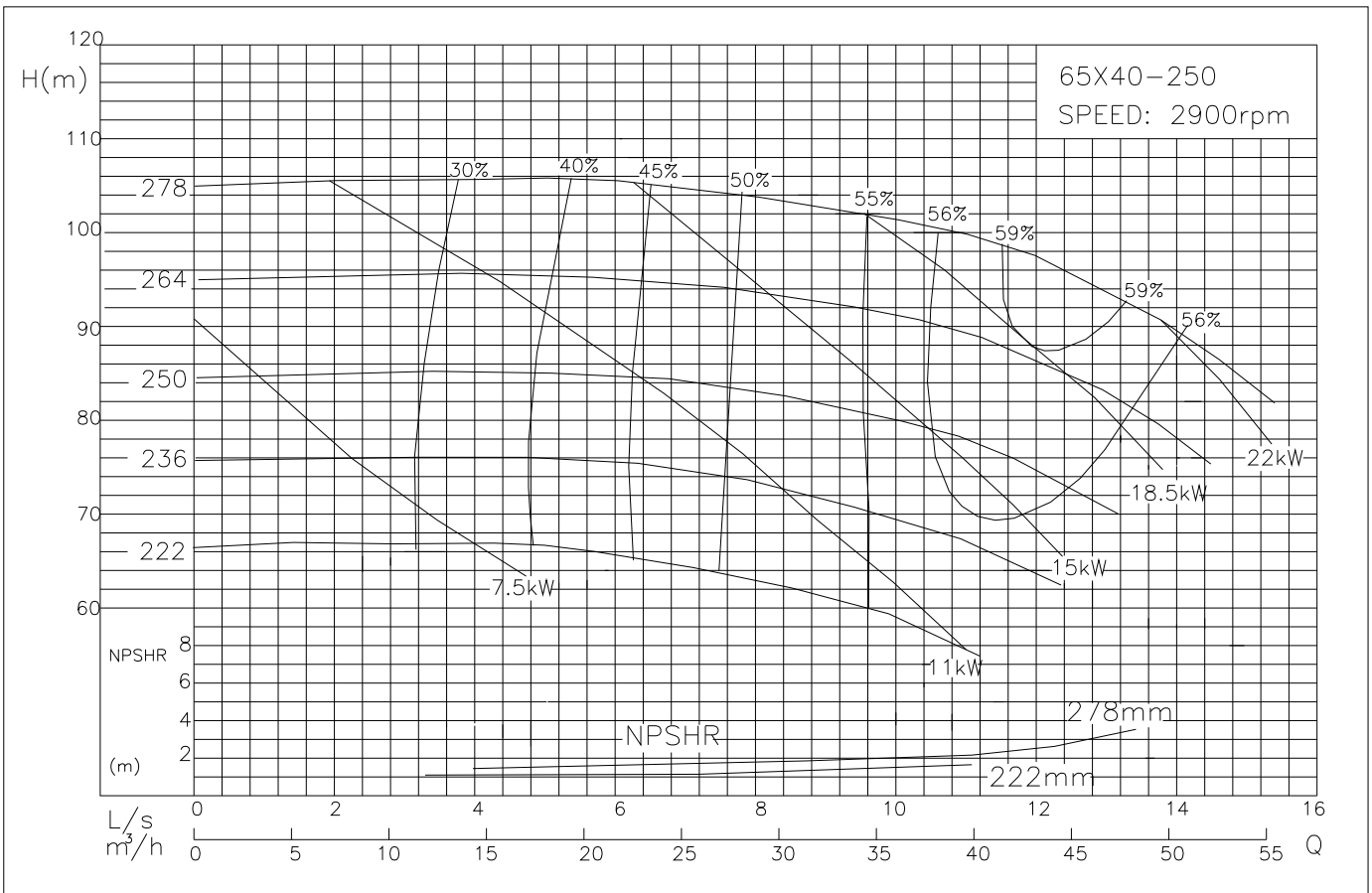
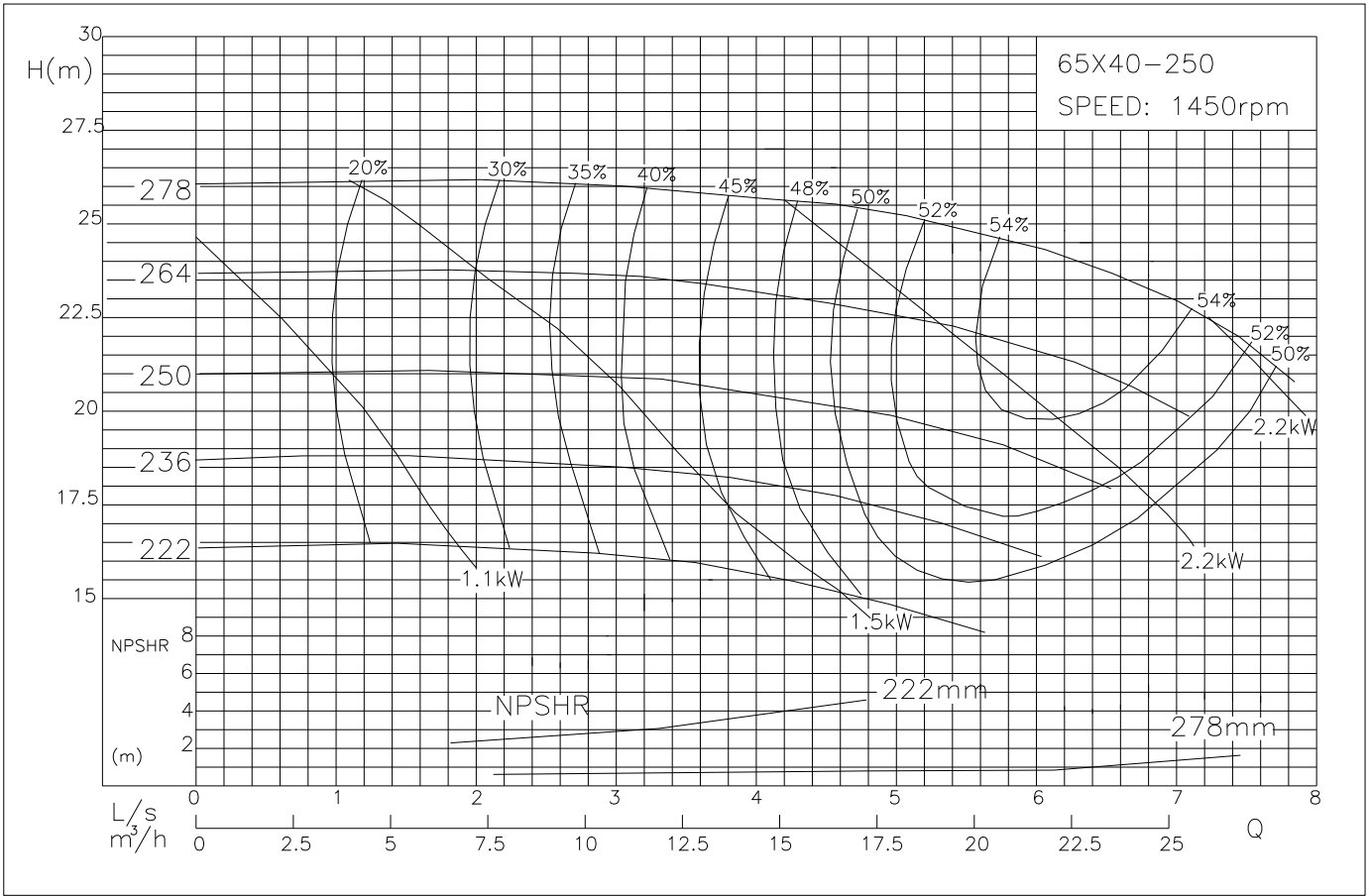

Performance Curves

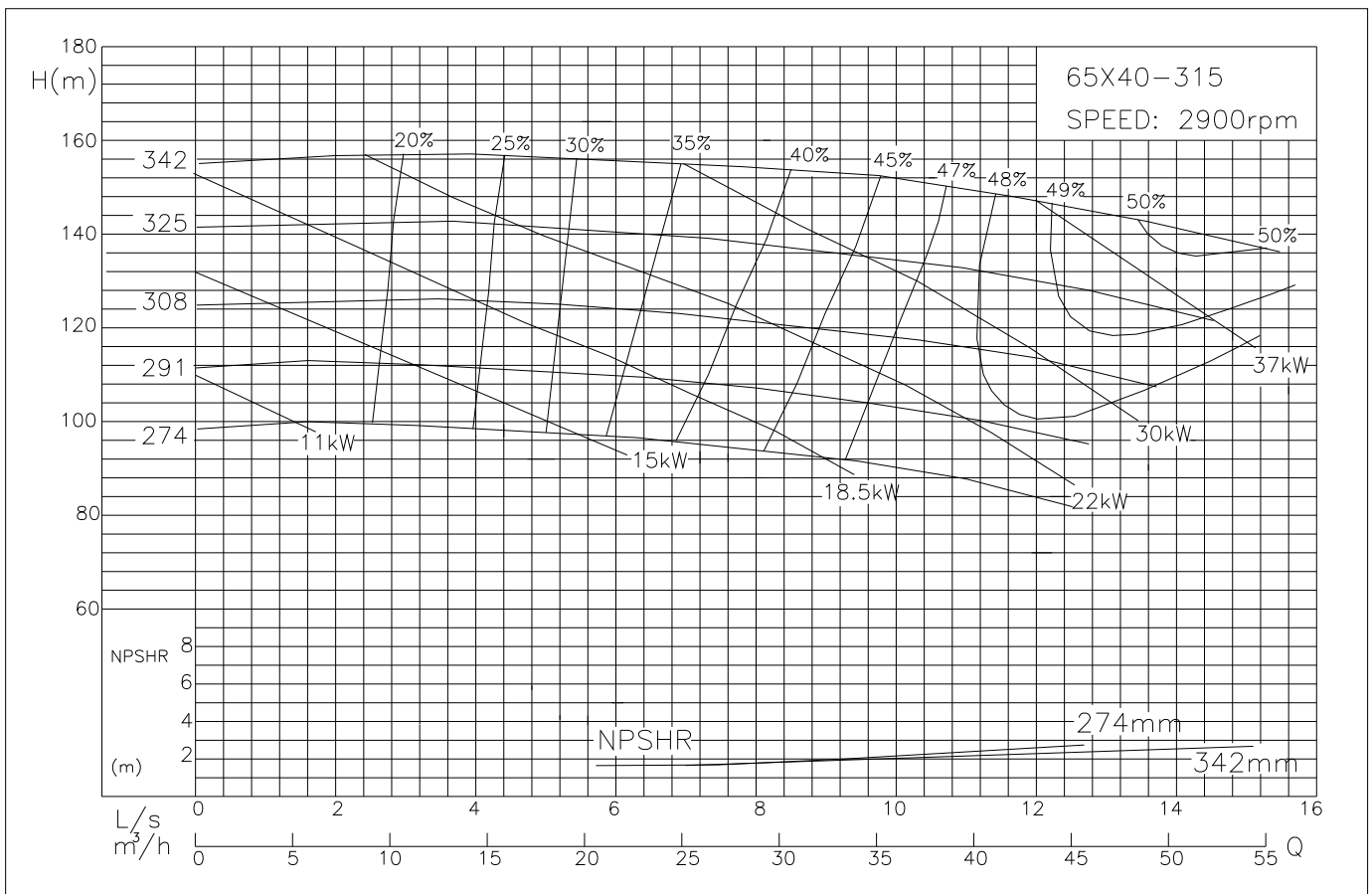
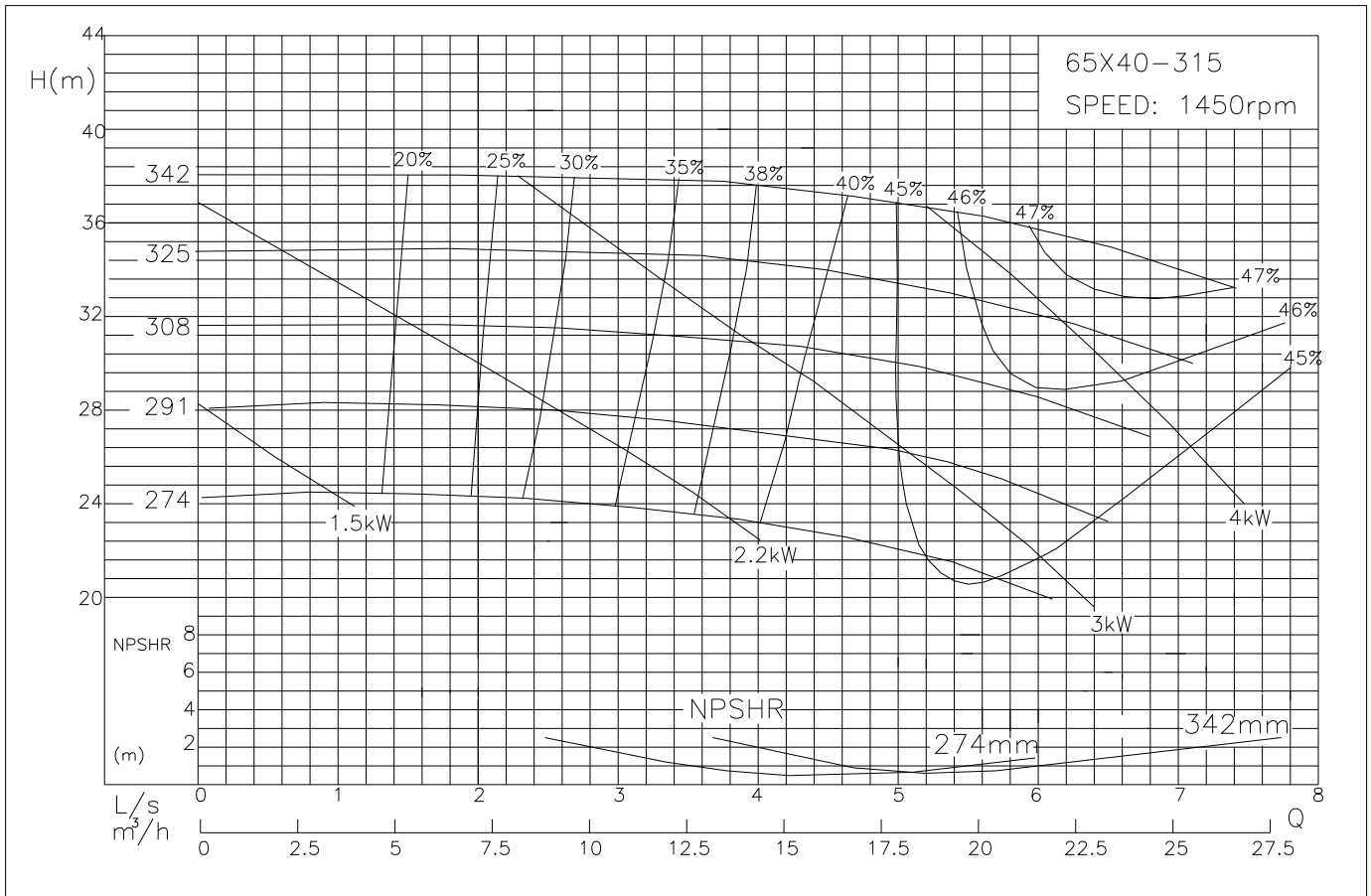

Performance Curves

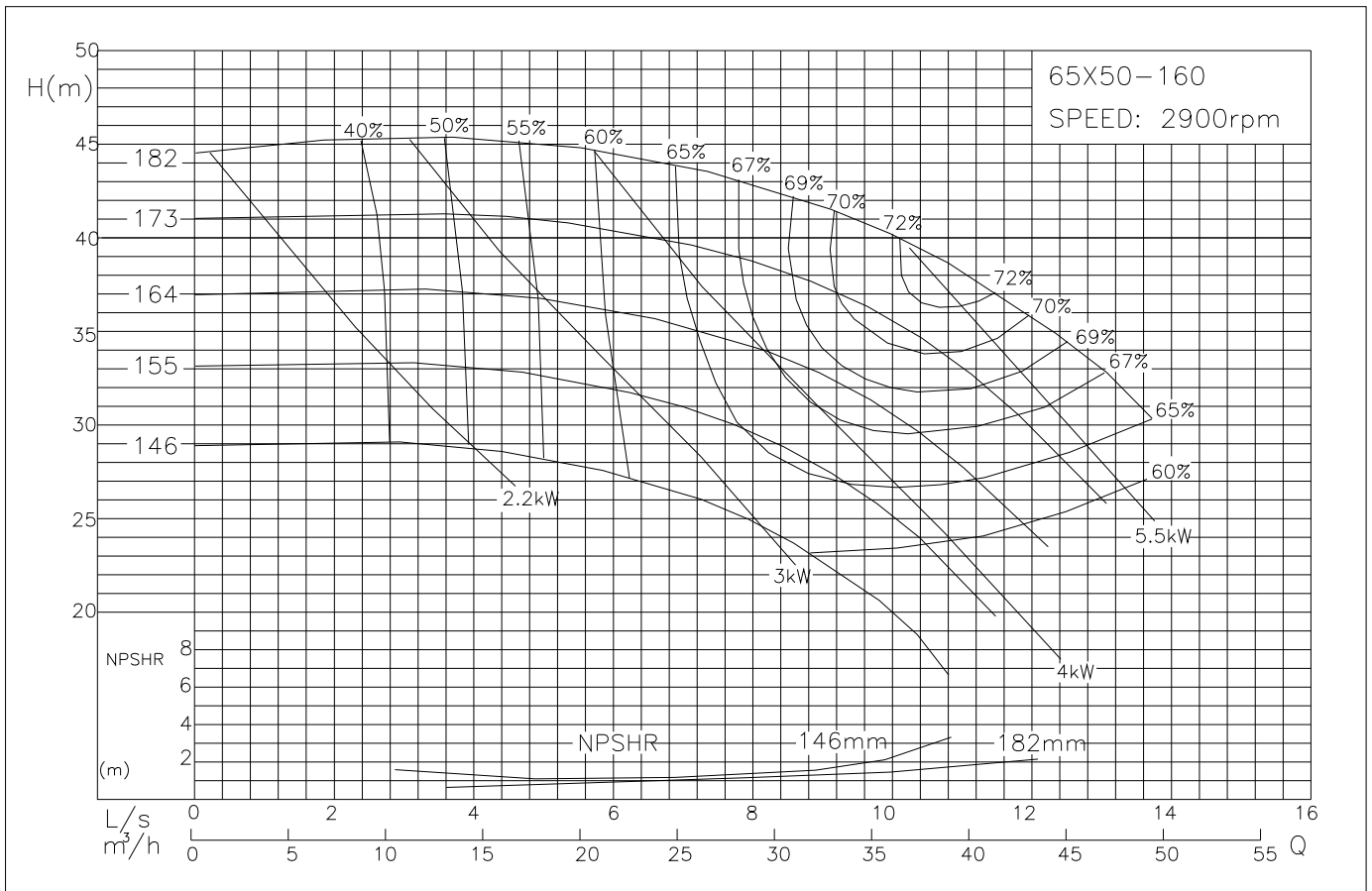
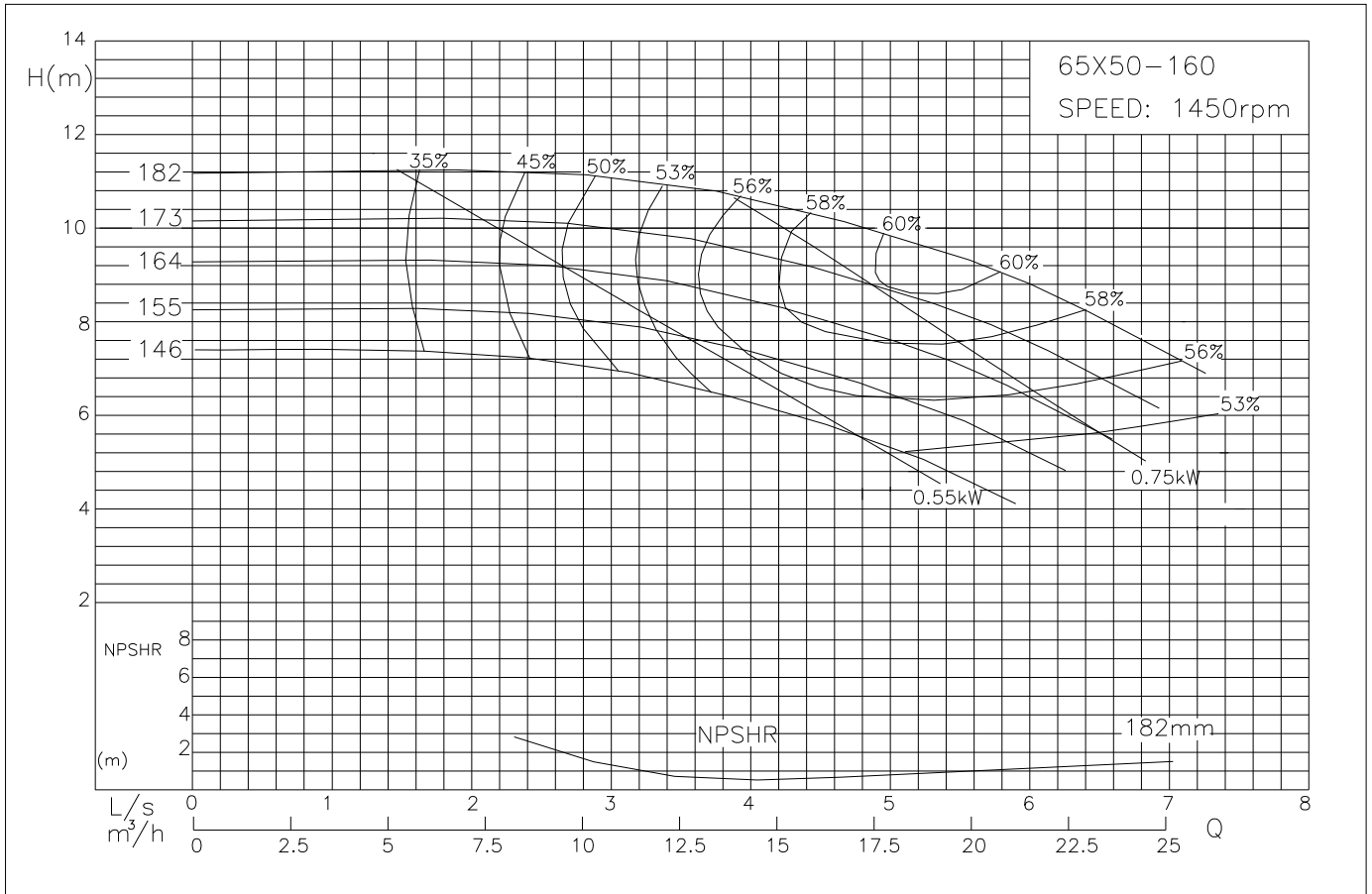

Performance Curves

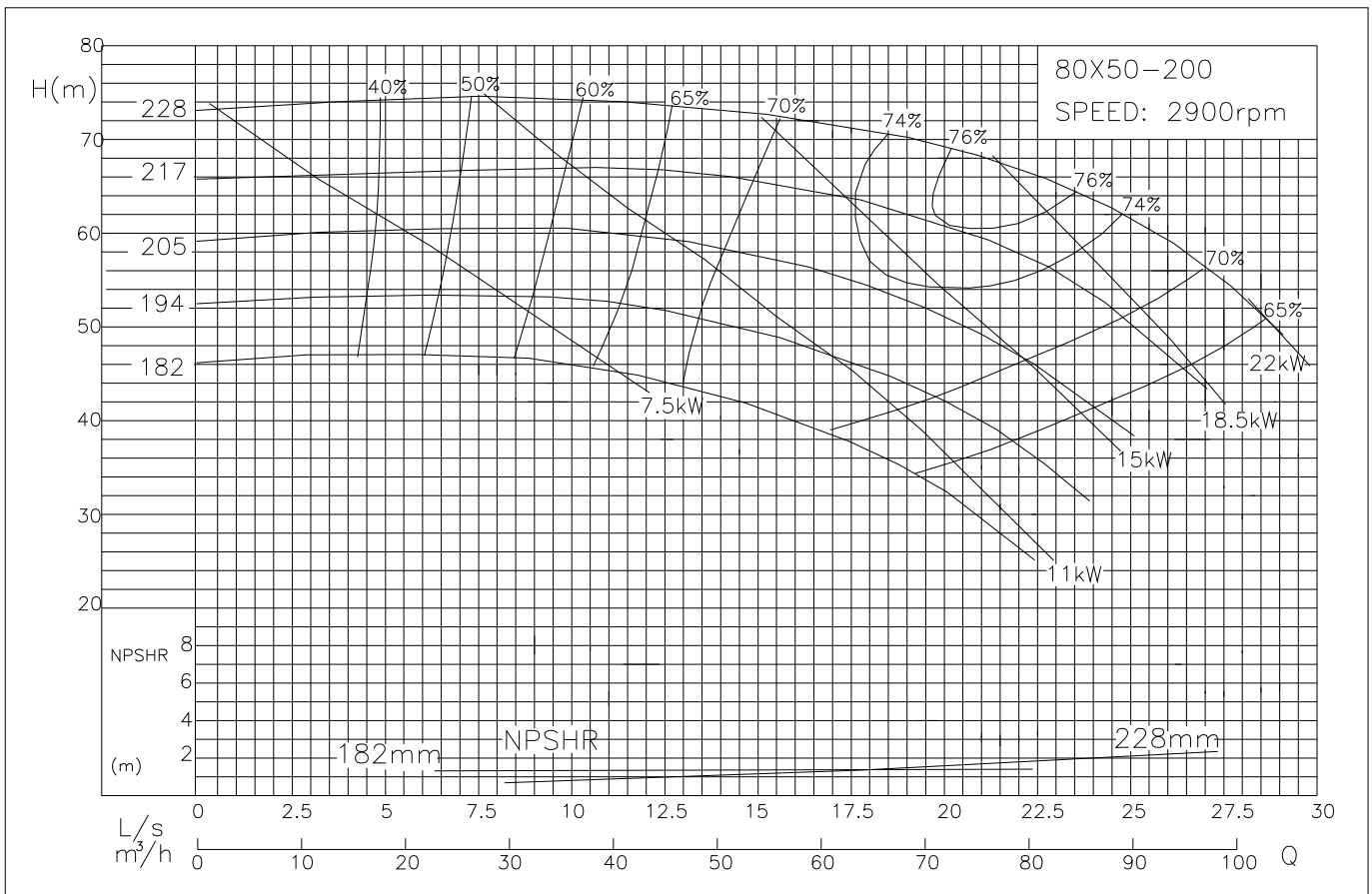
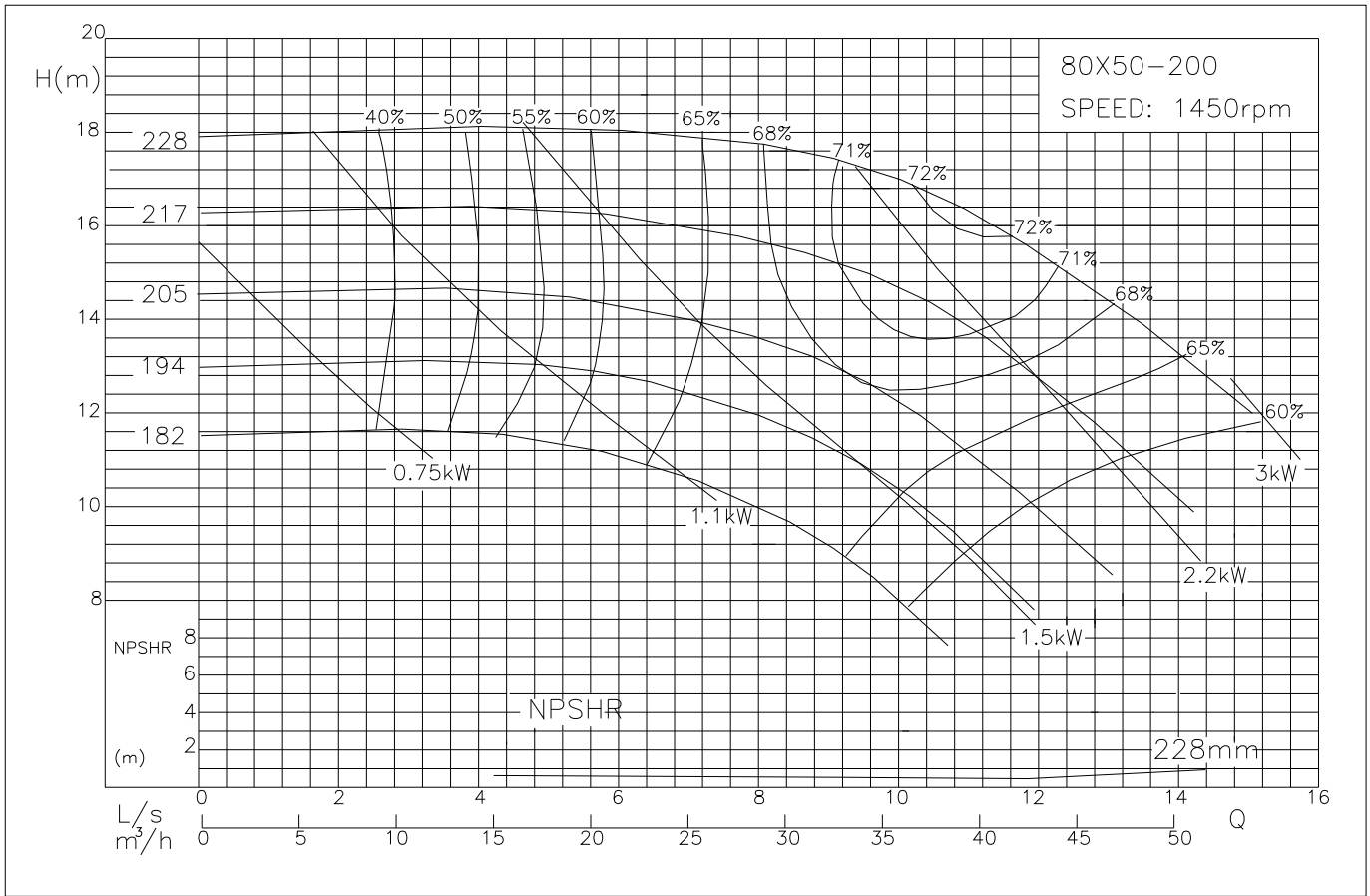

Performance Curves

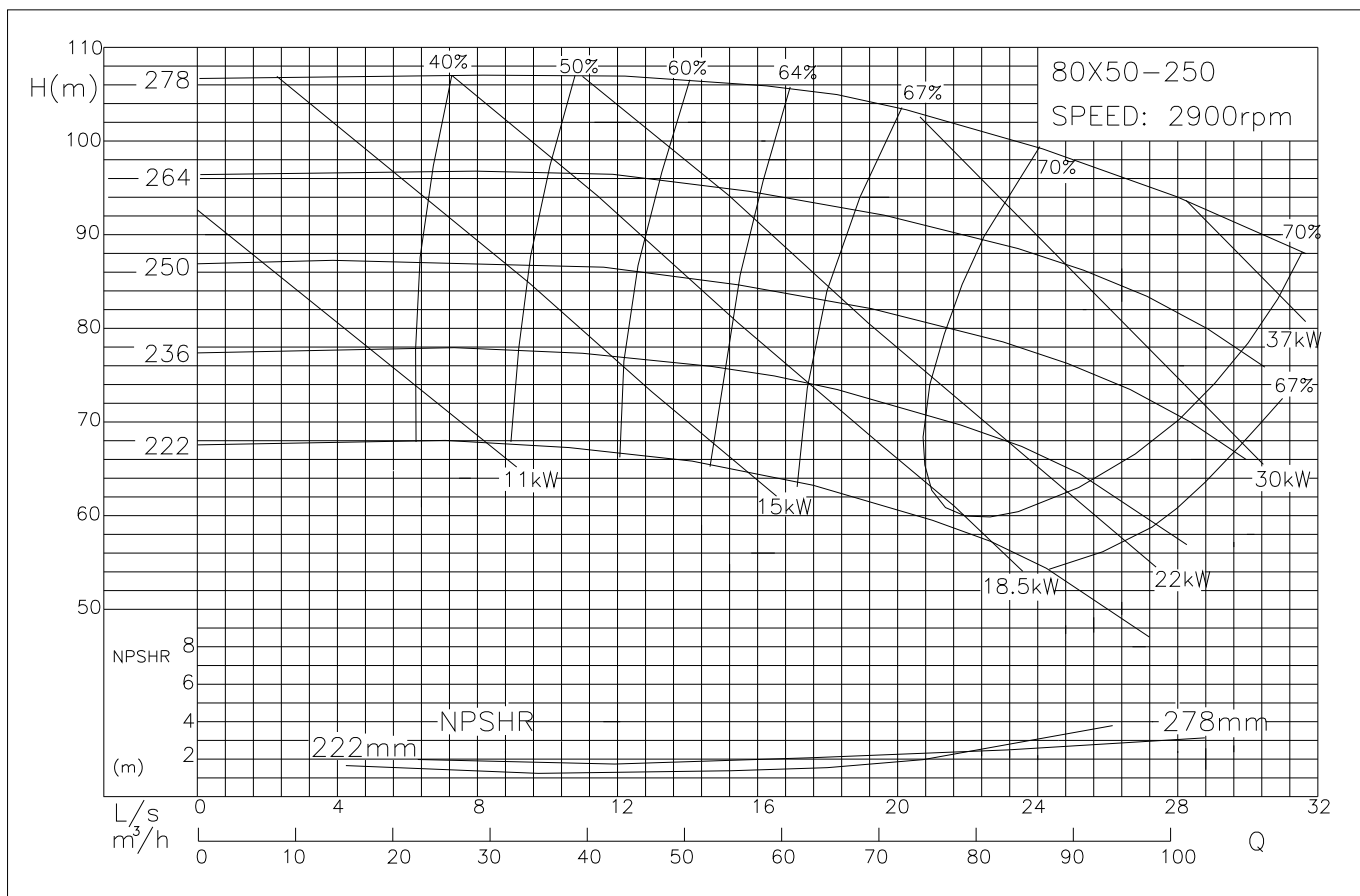
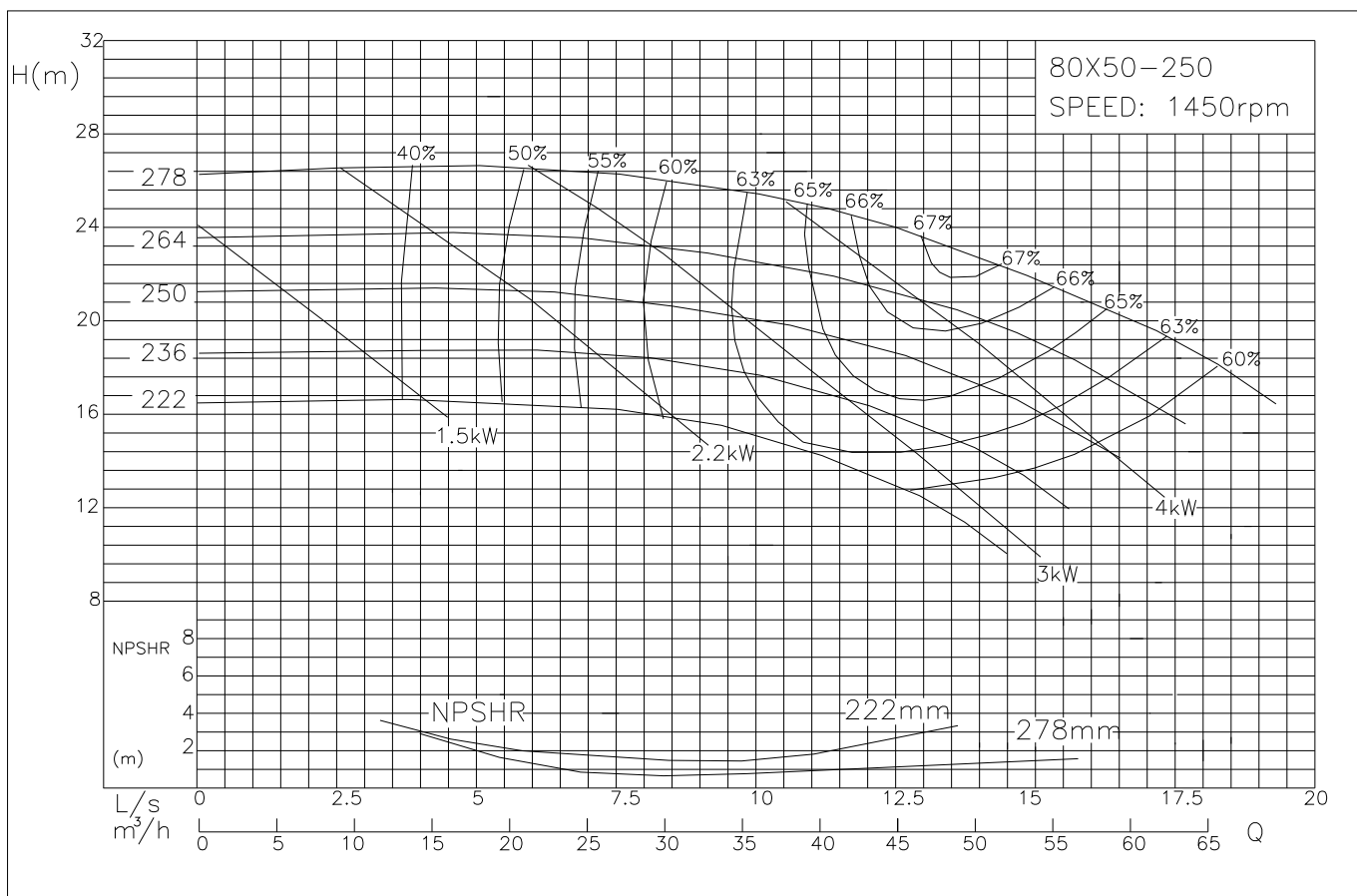





Performance Curves

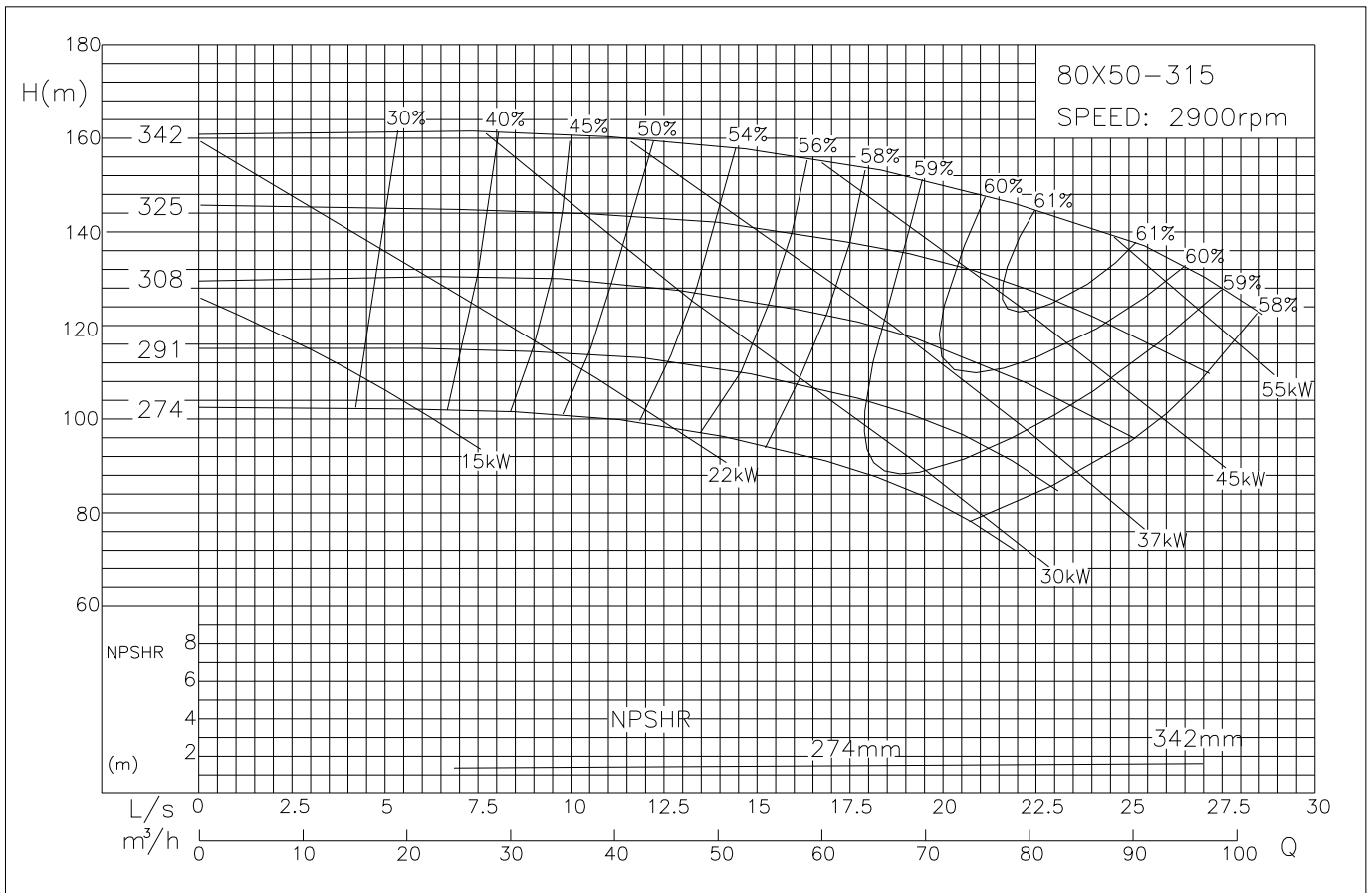
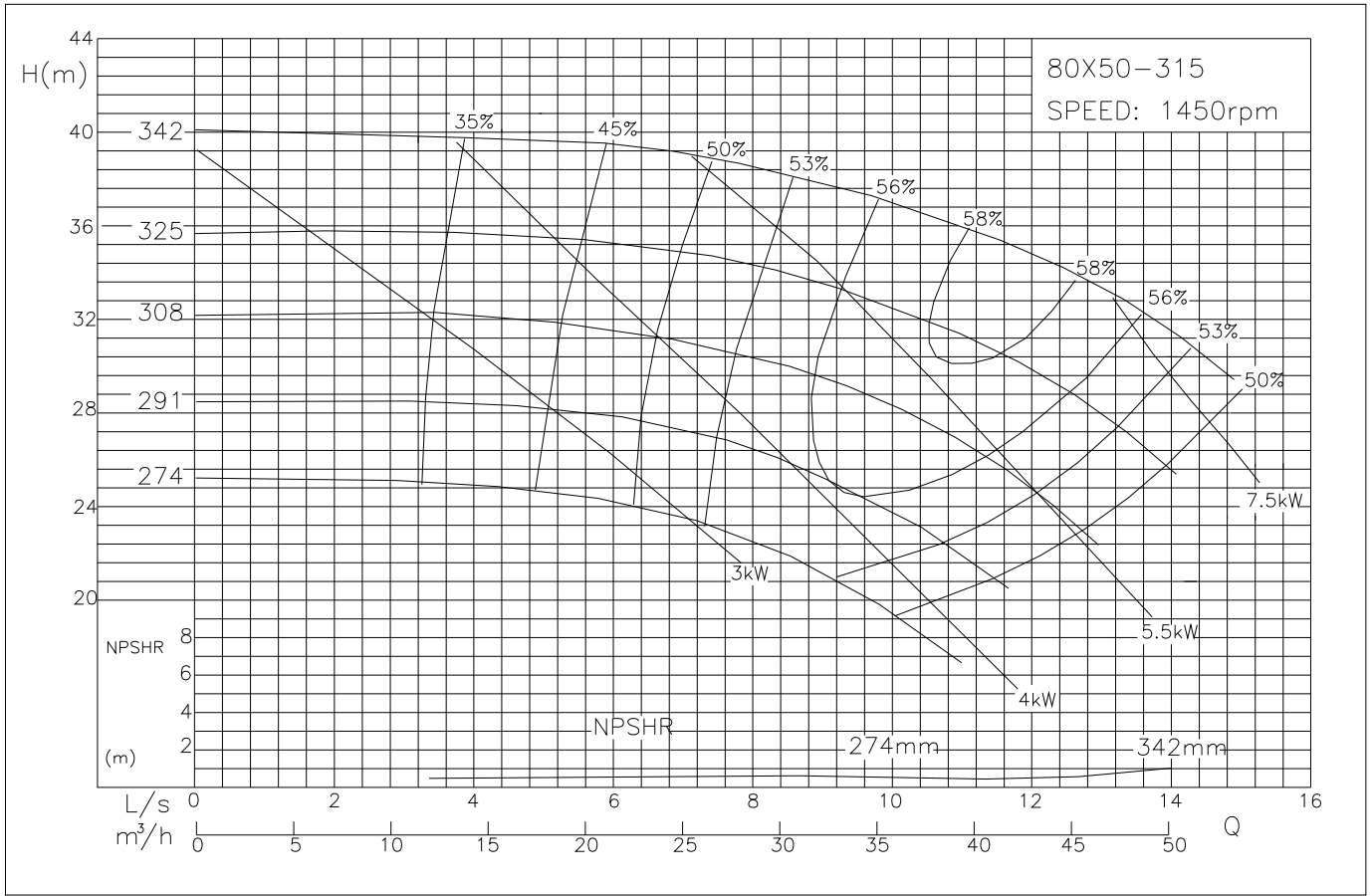



Performance Curves

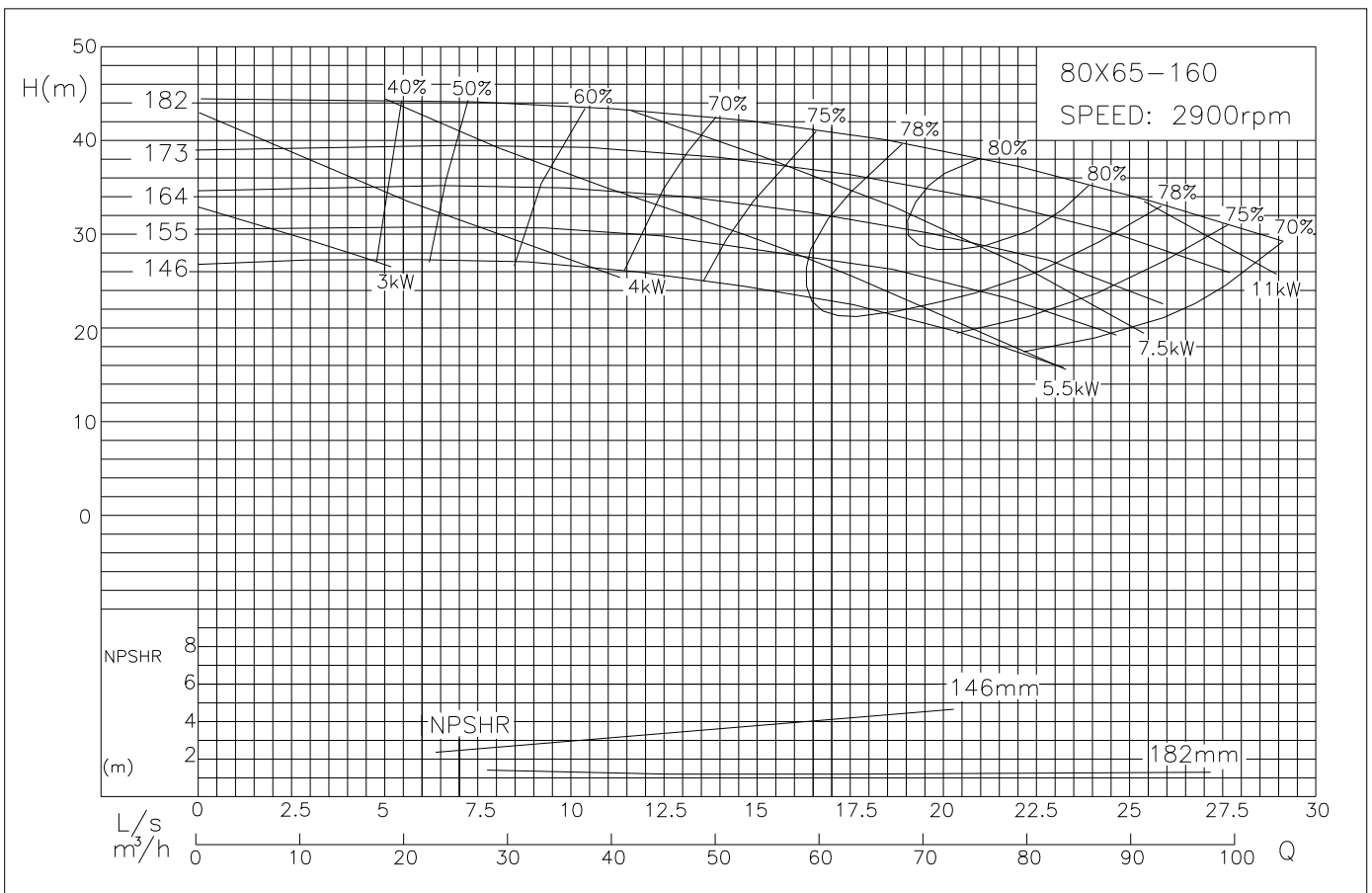
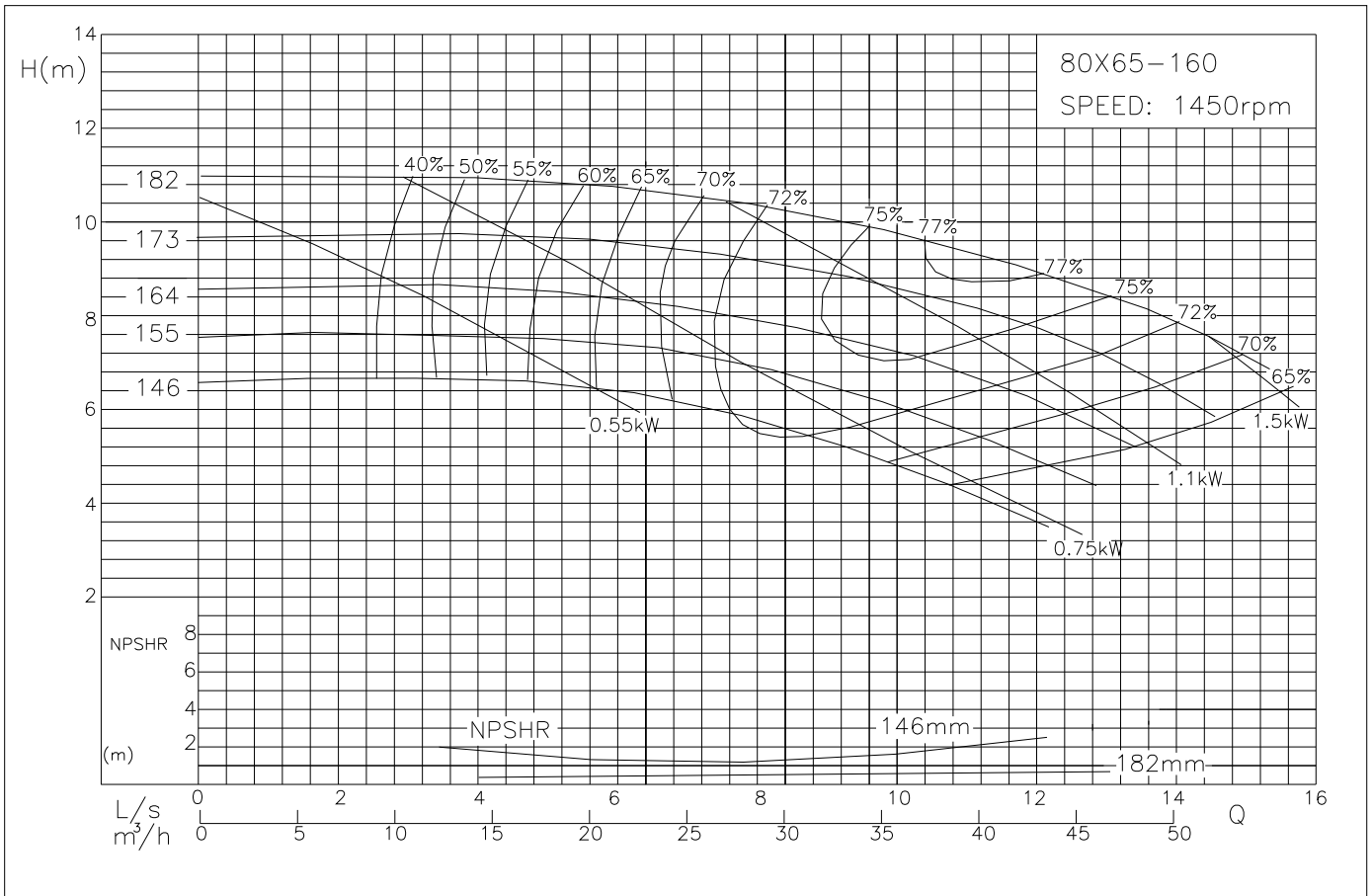



Performance Curves

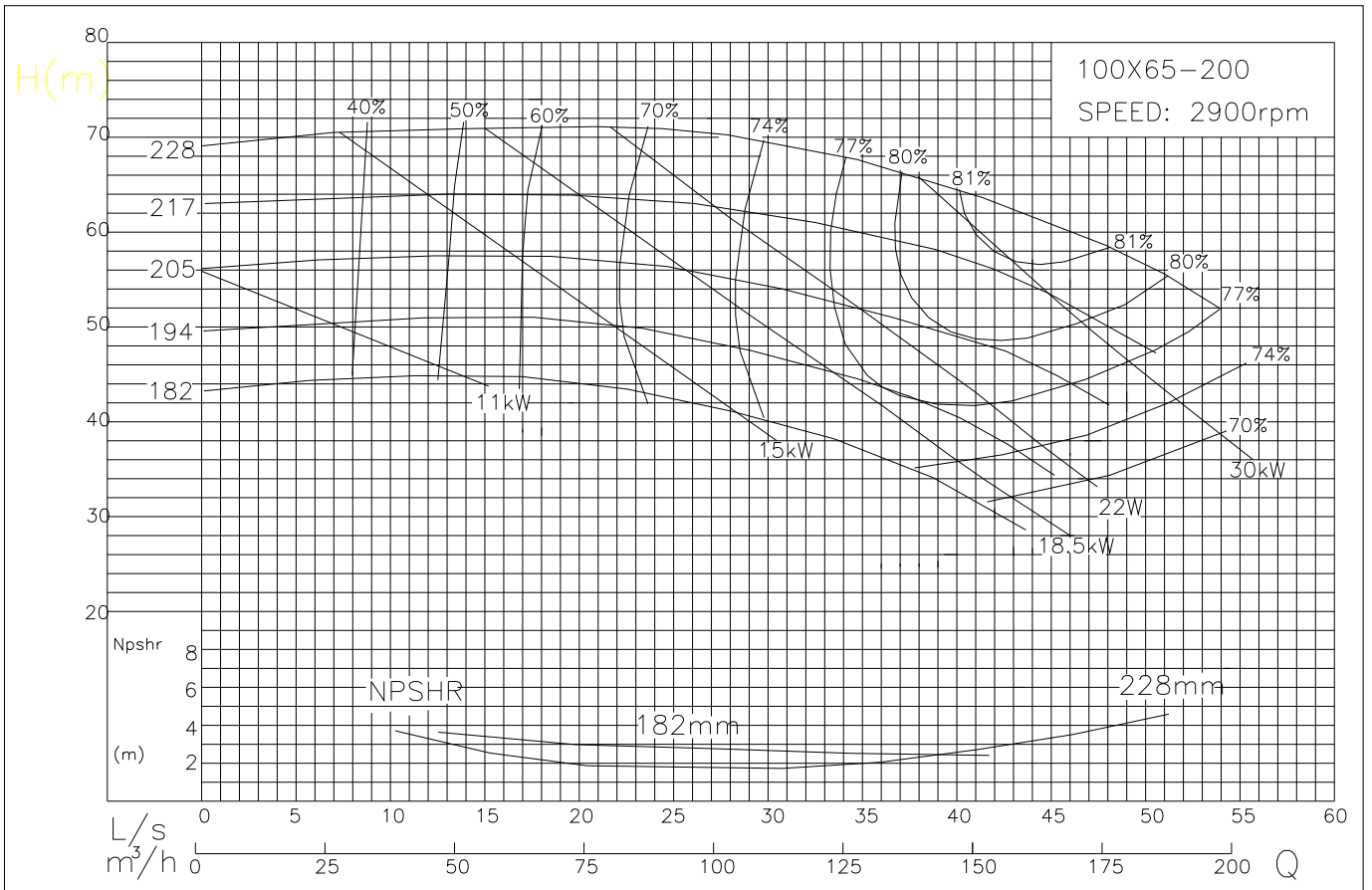
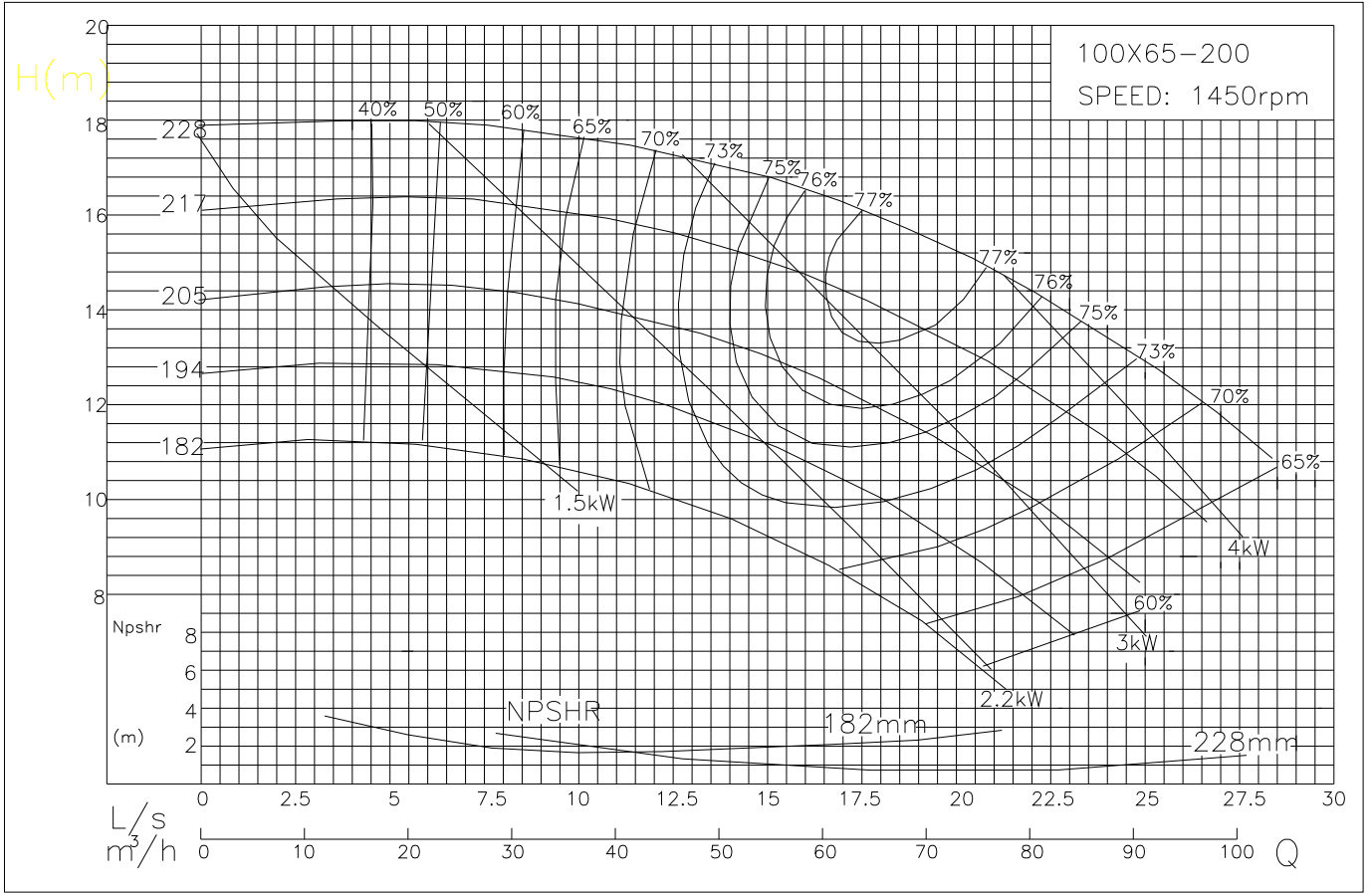



Performance Curves

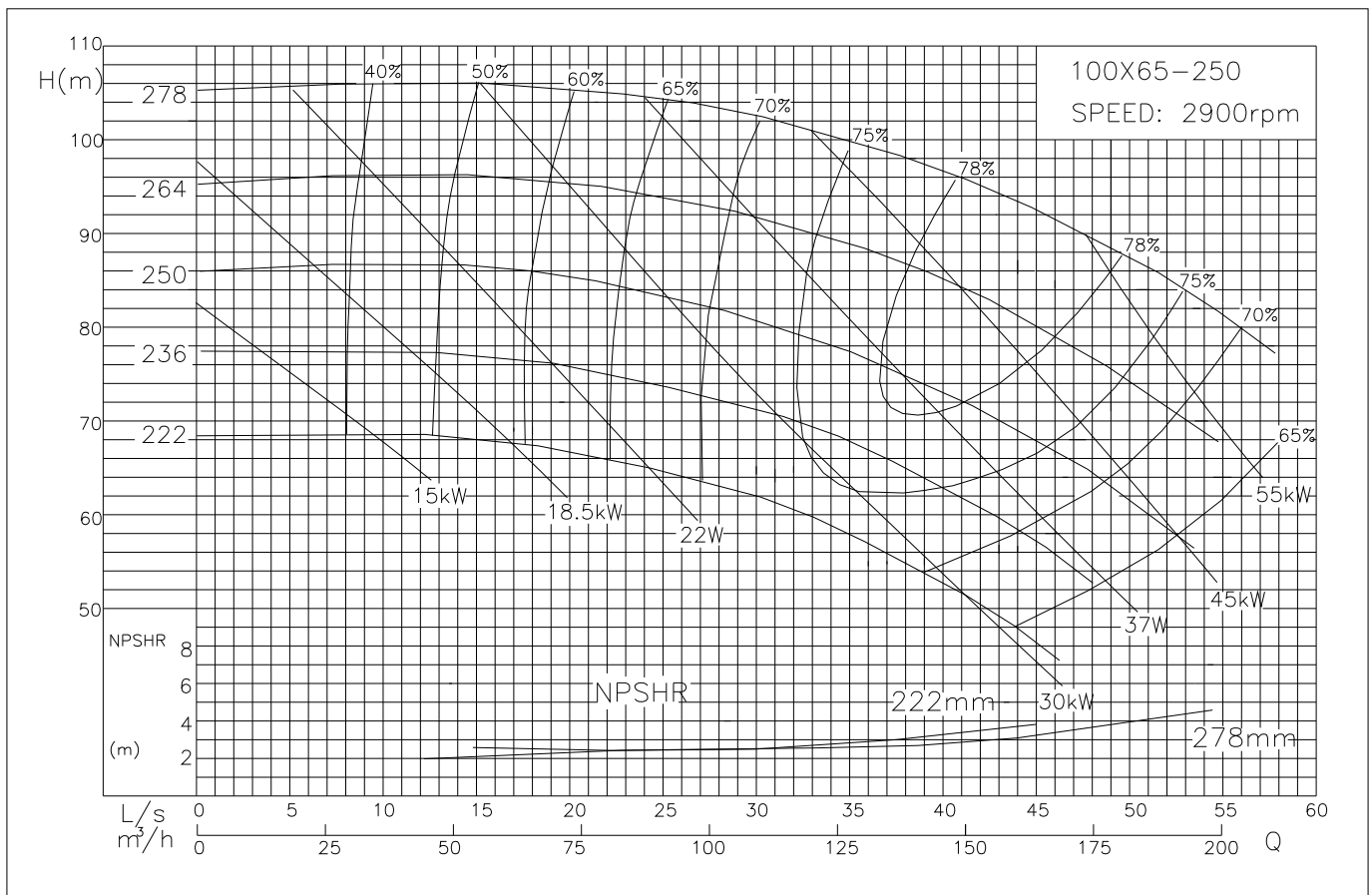
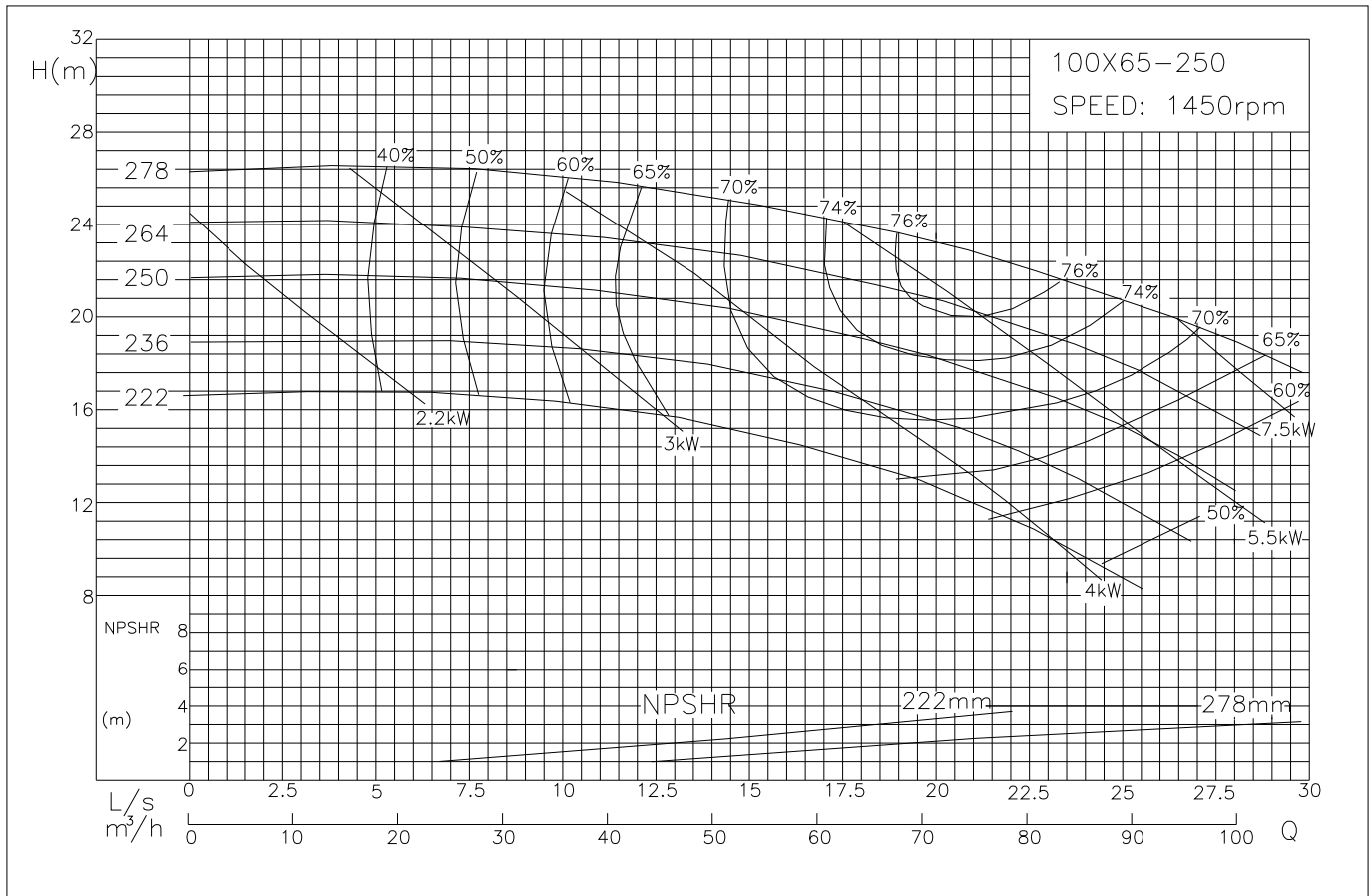



Performance Curves

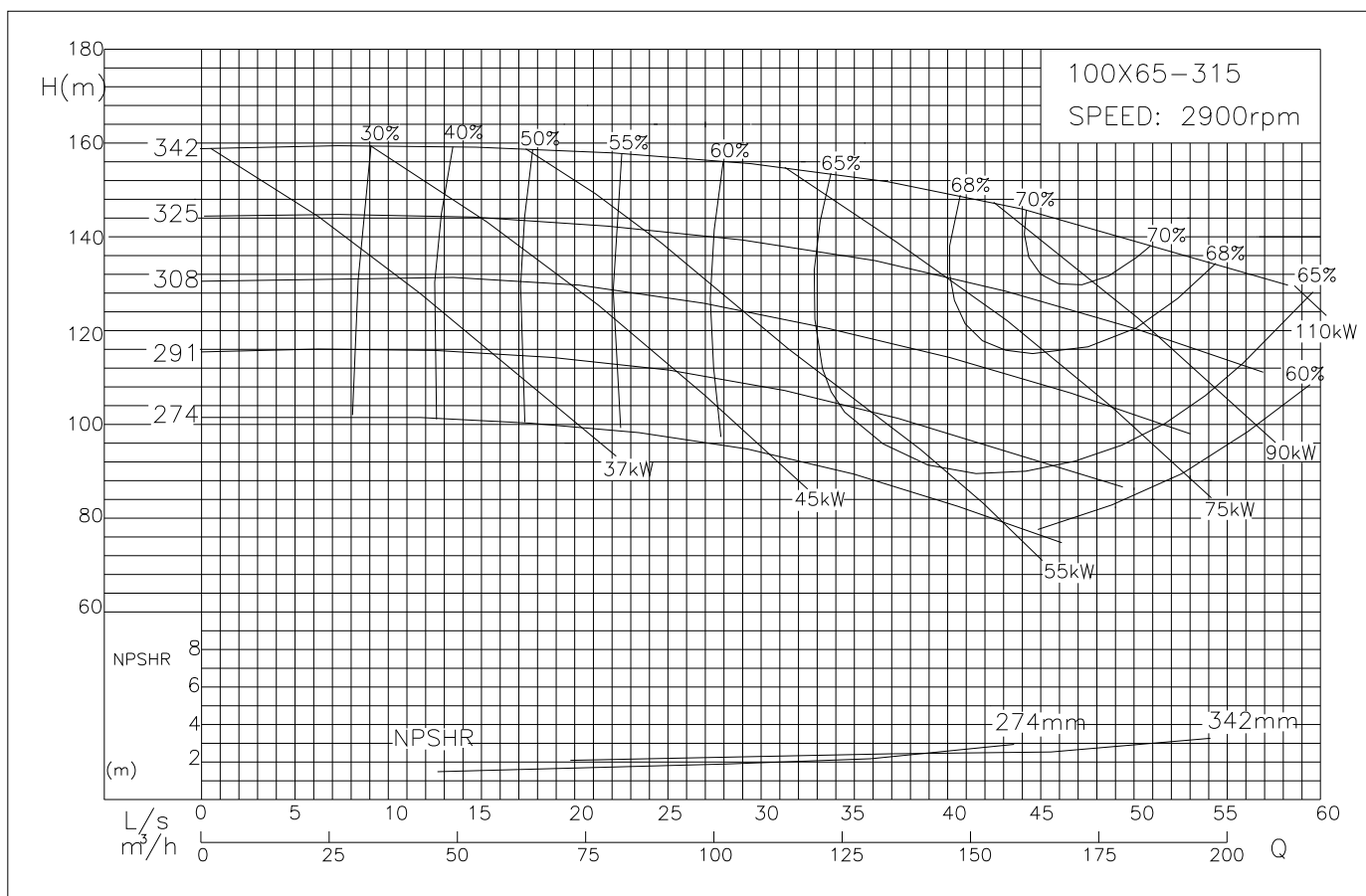
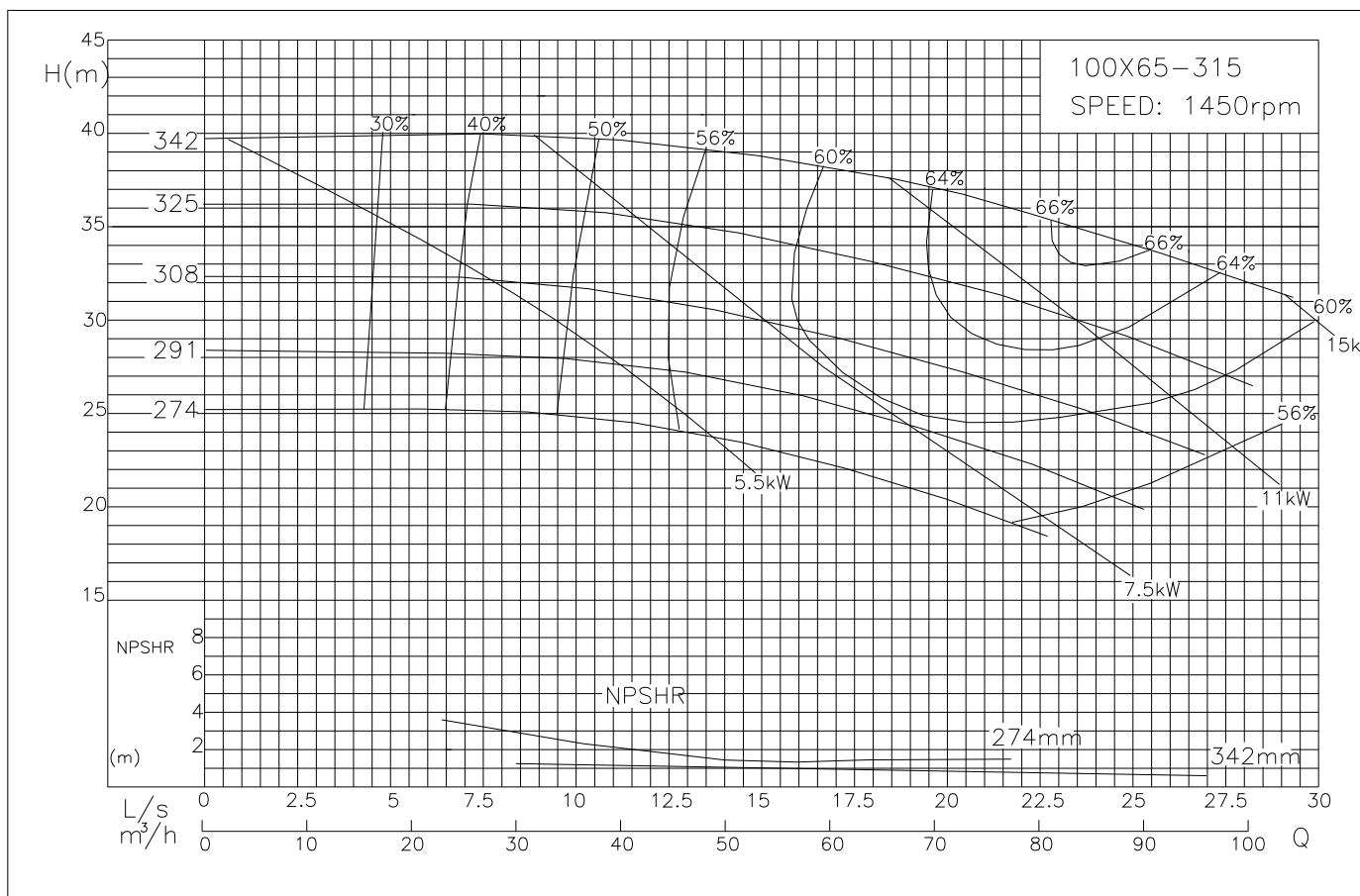



Performance Curves

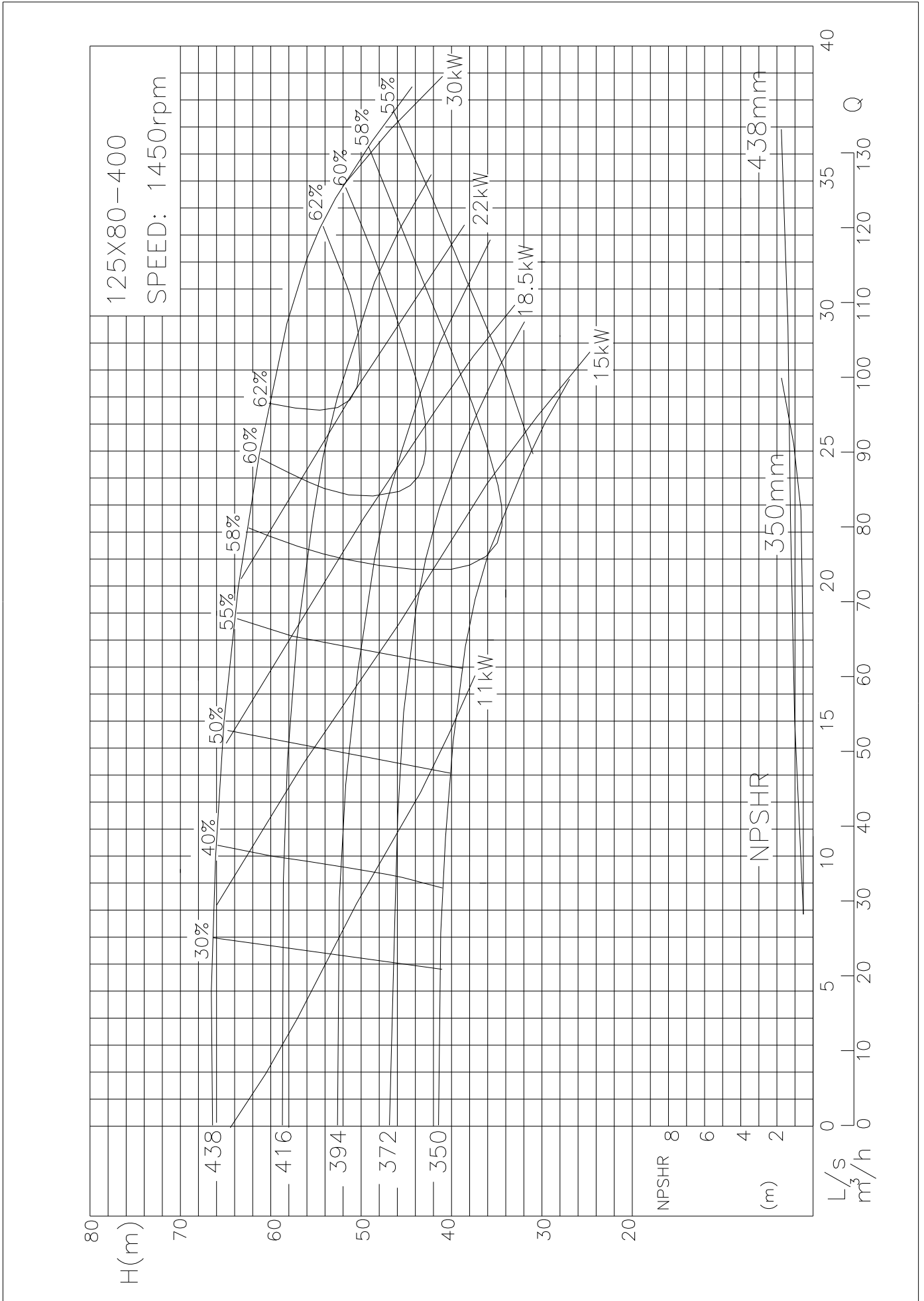



Performance Curves

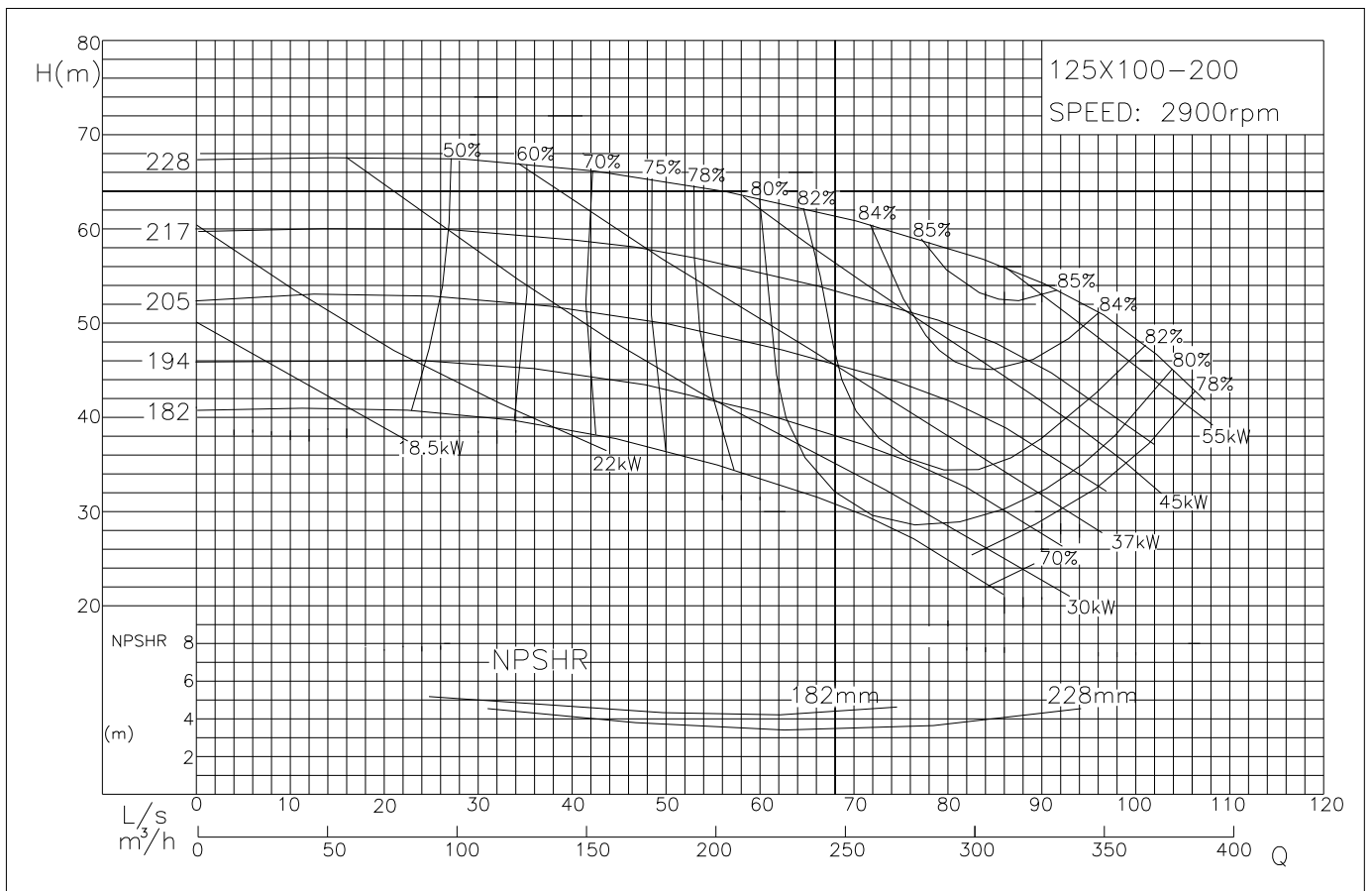
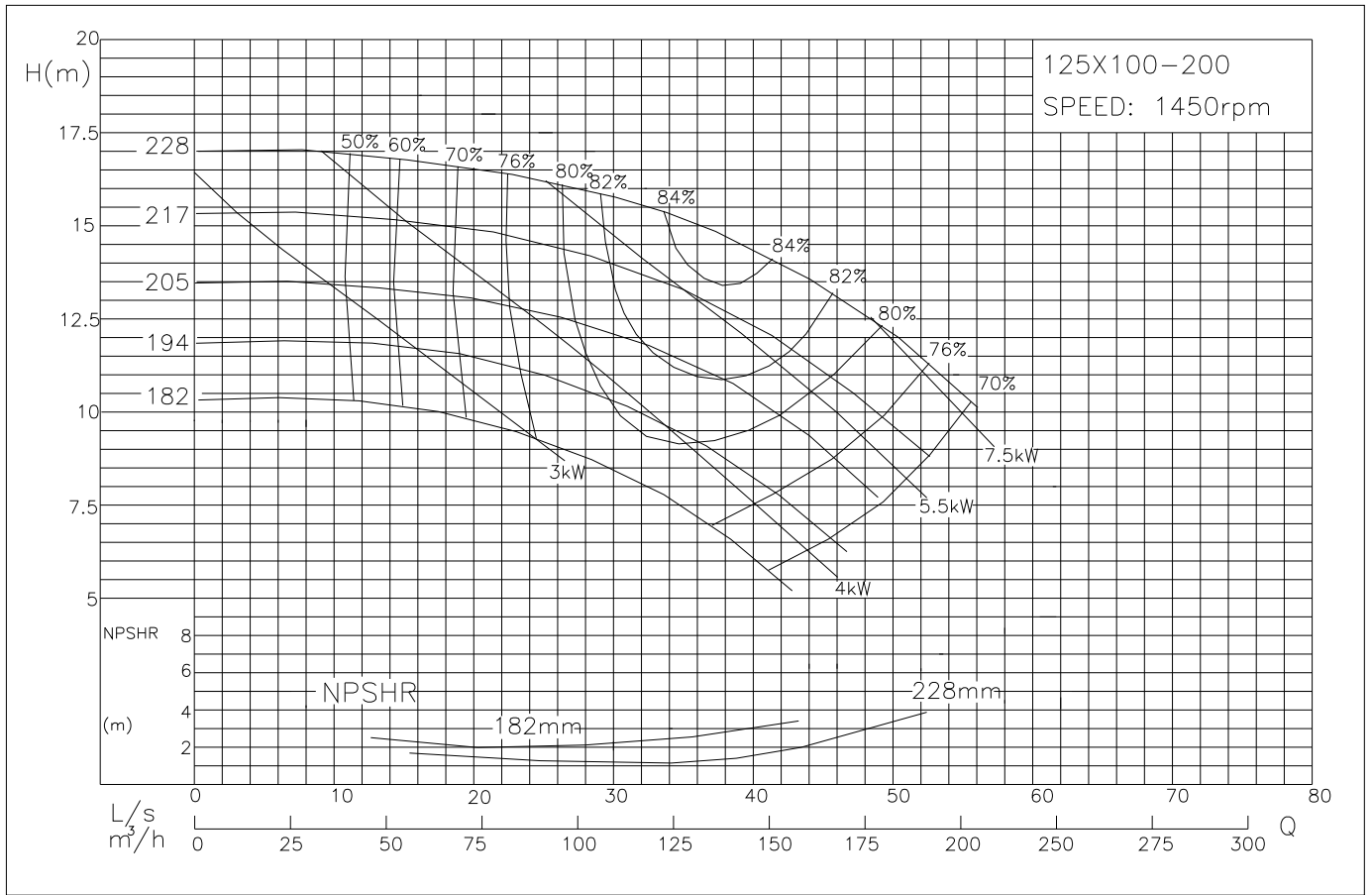





Performance Curves

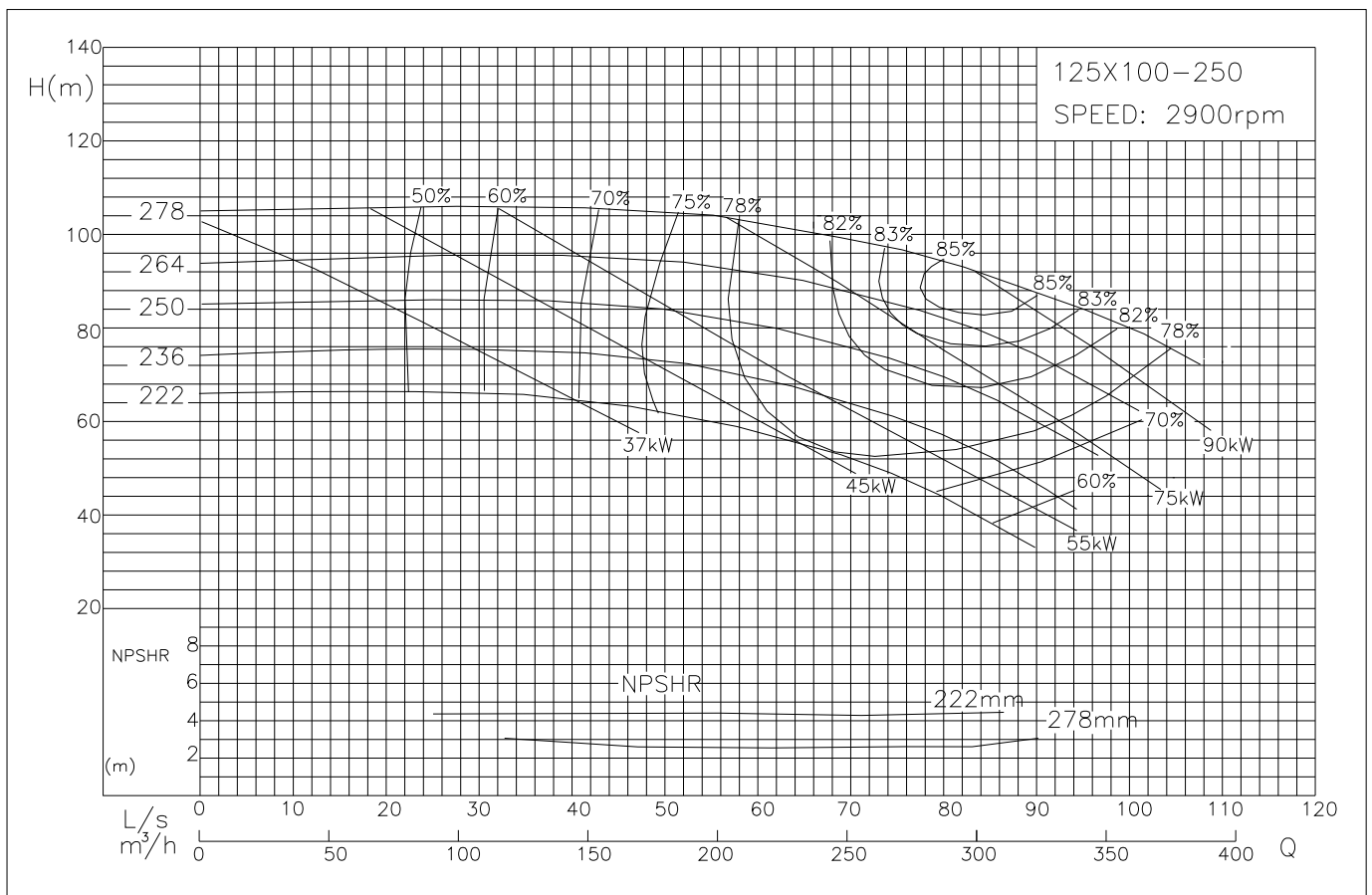
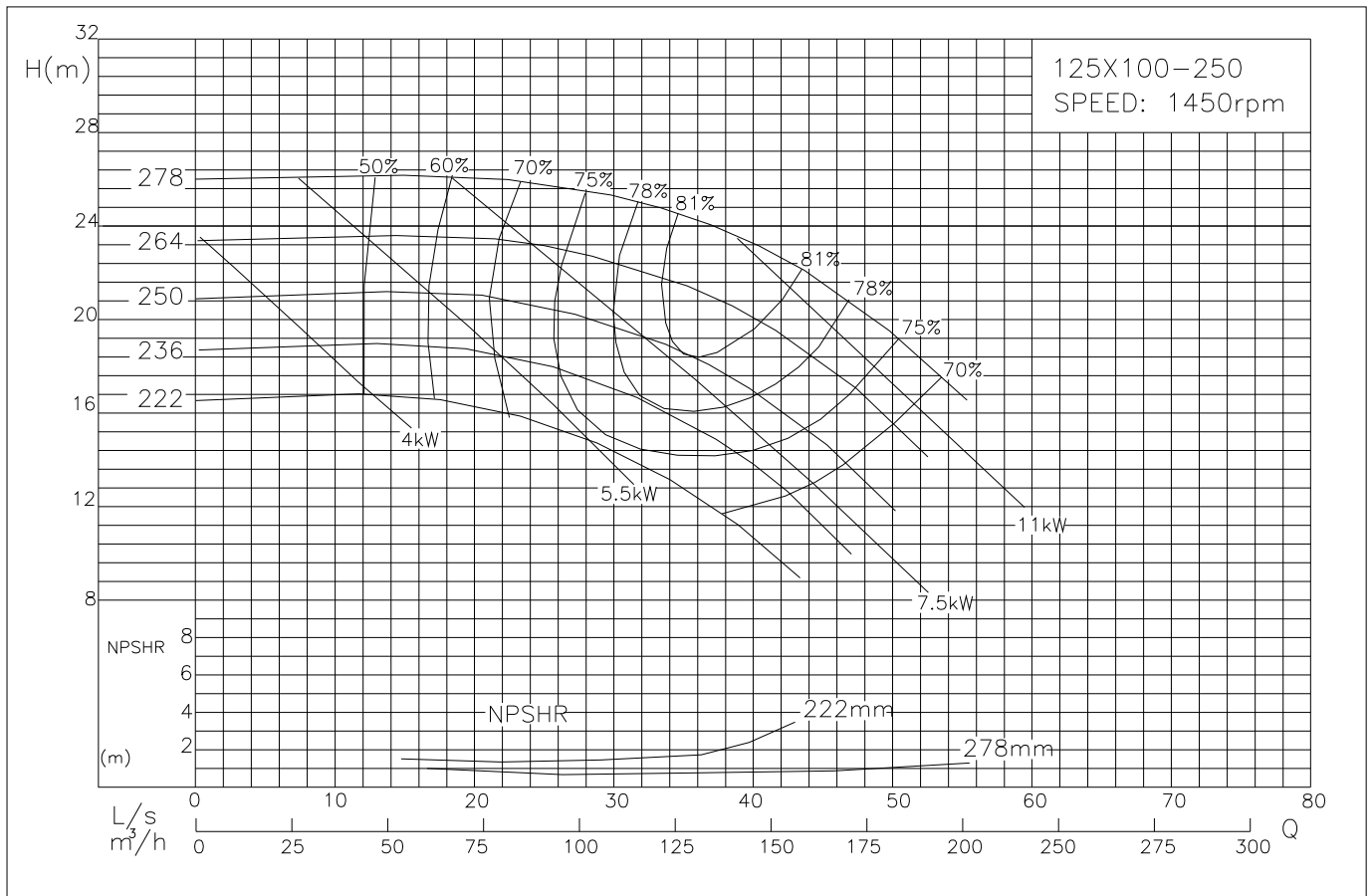



Performance Curves

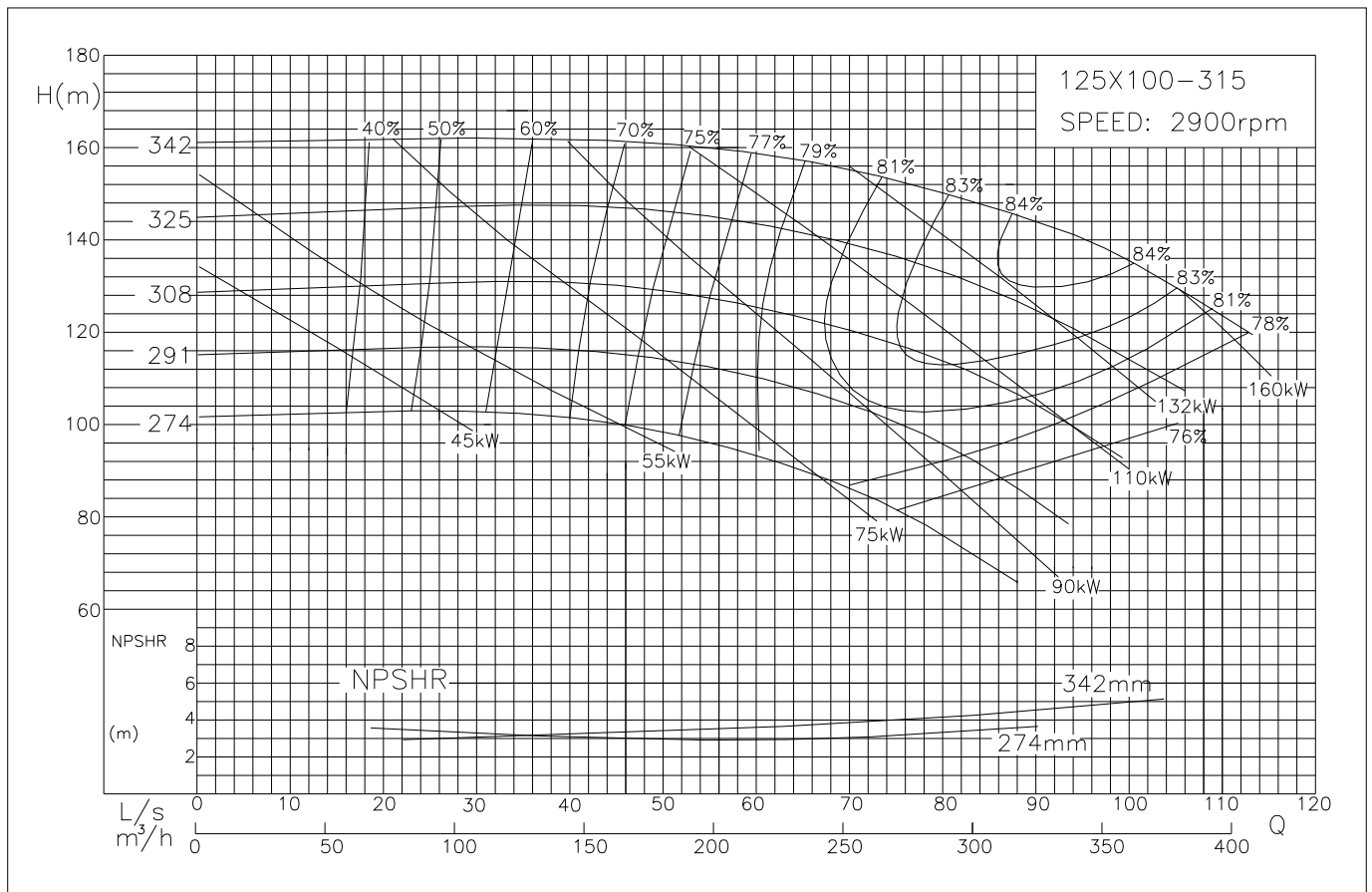
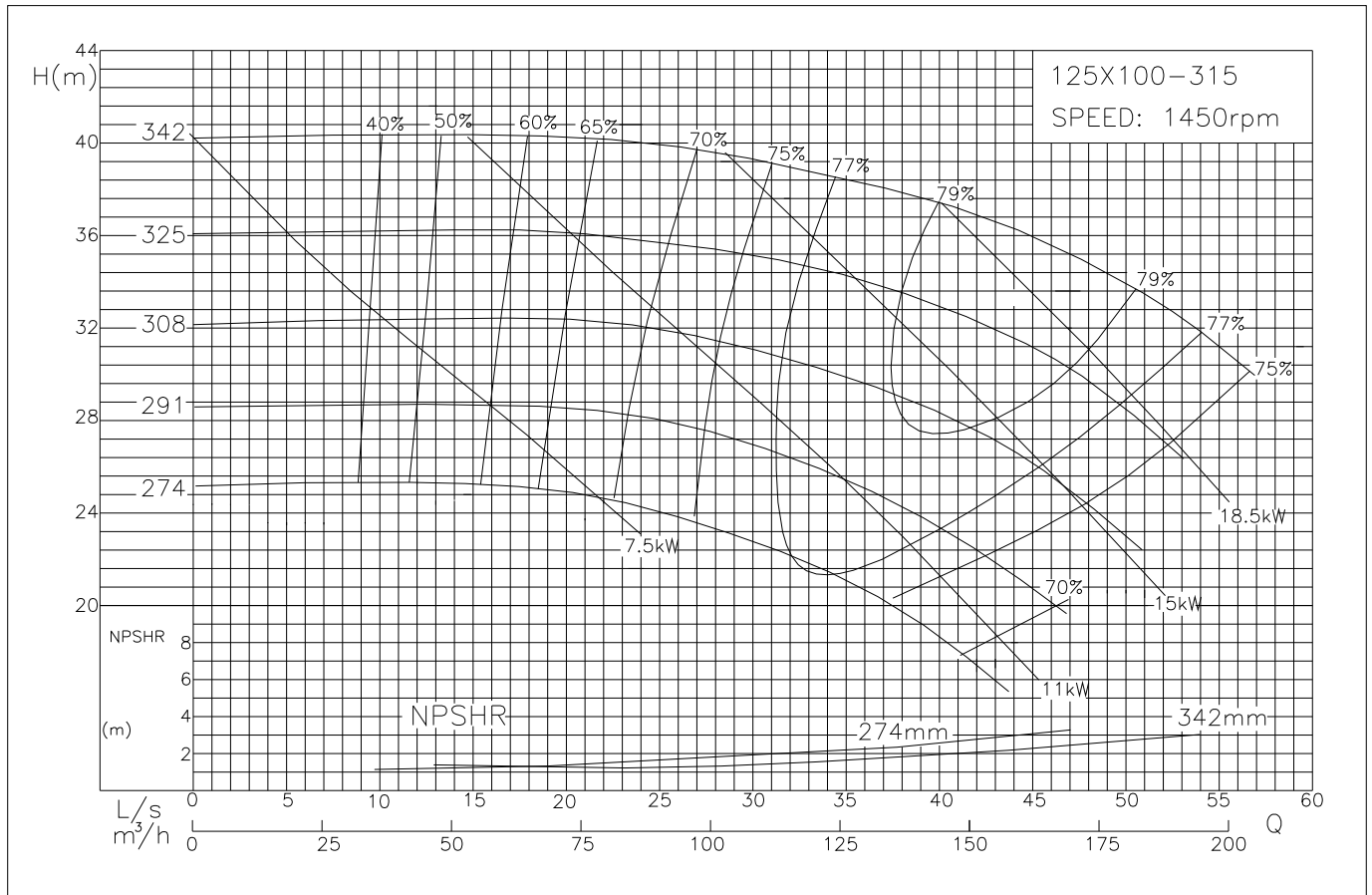

Performance Curves

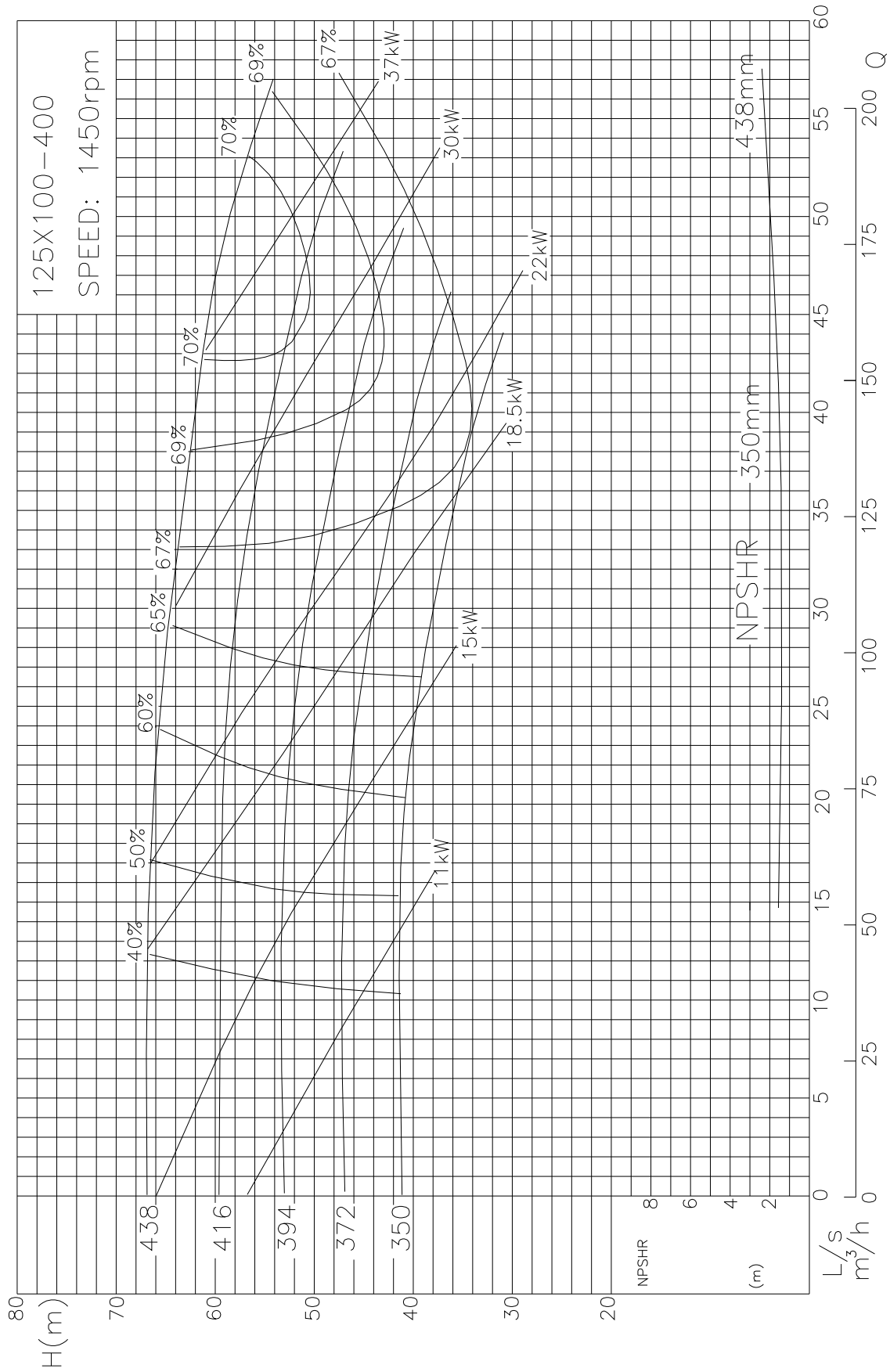

Performance Curves

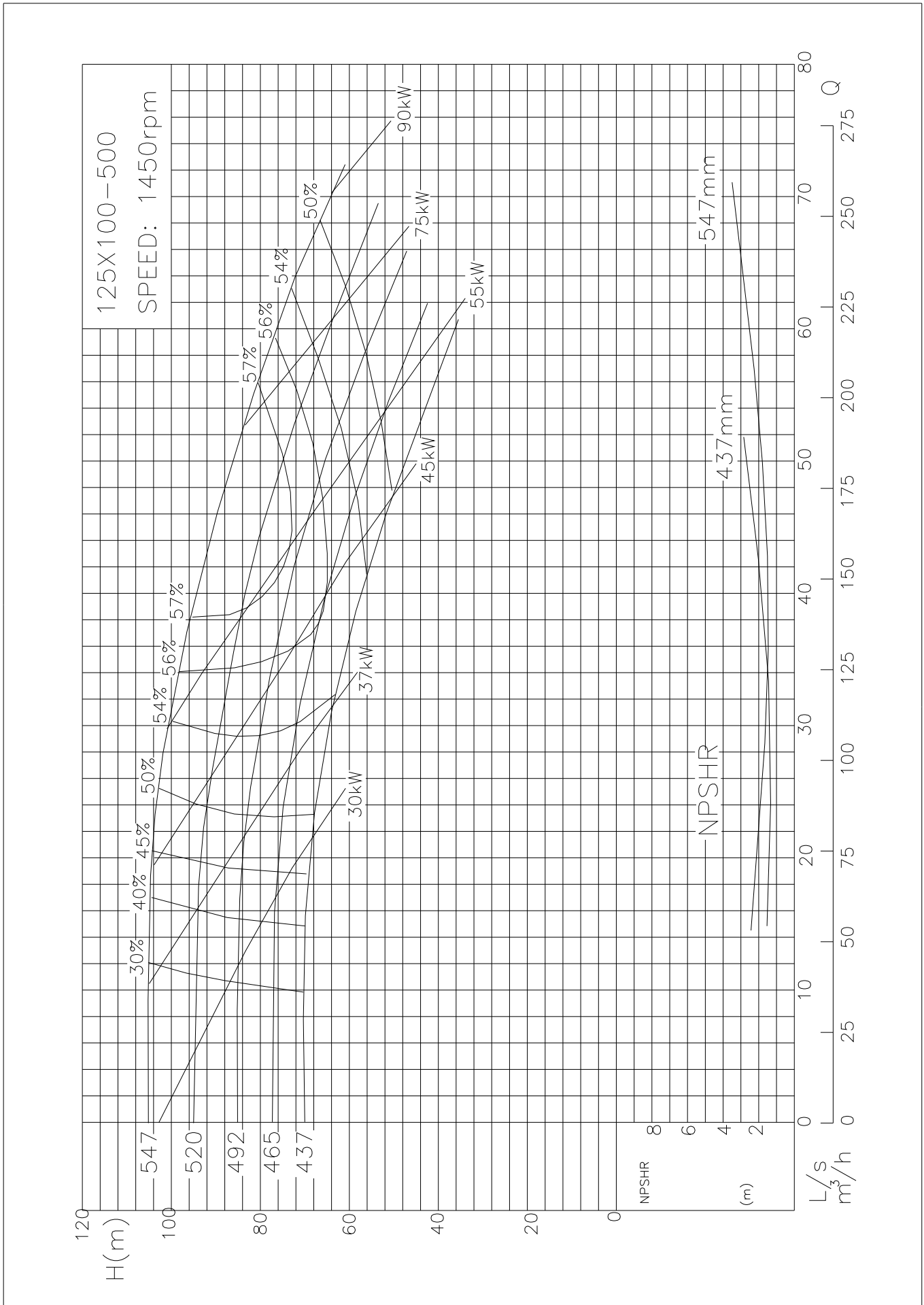

Performance Curves

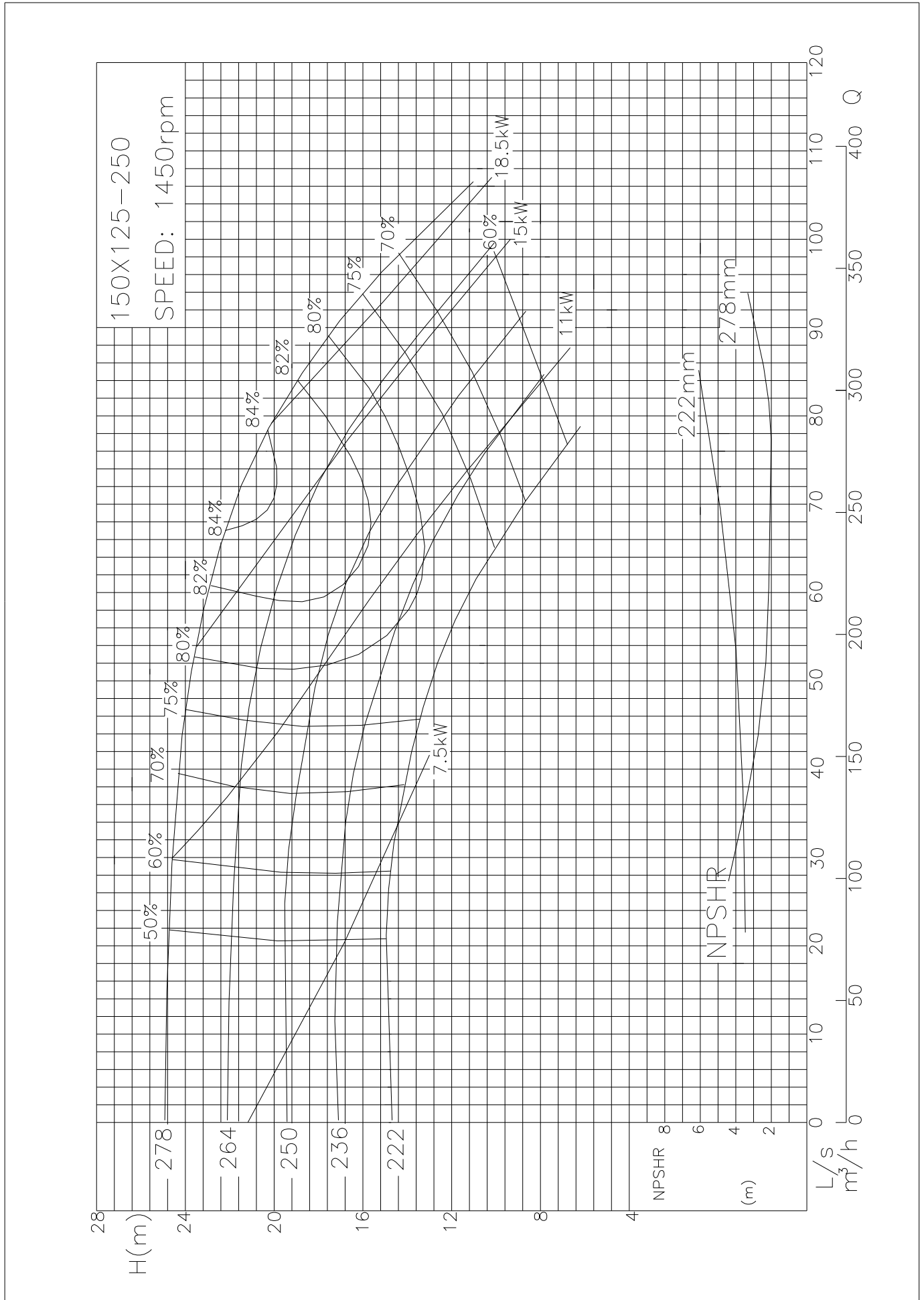

性能曲

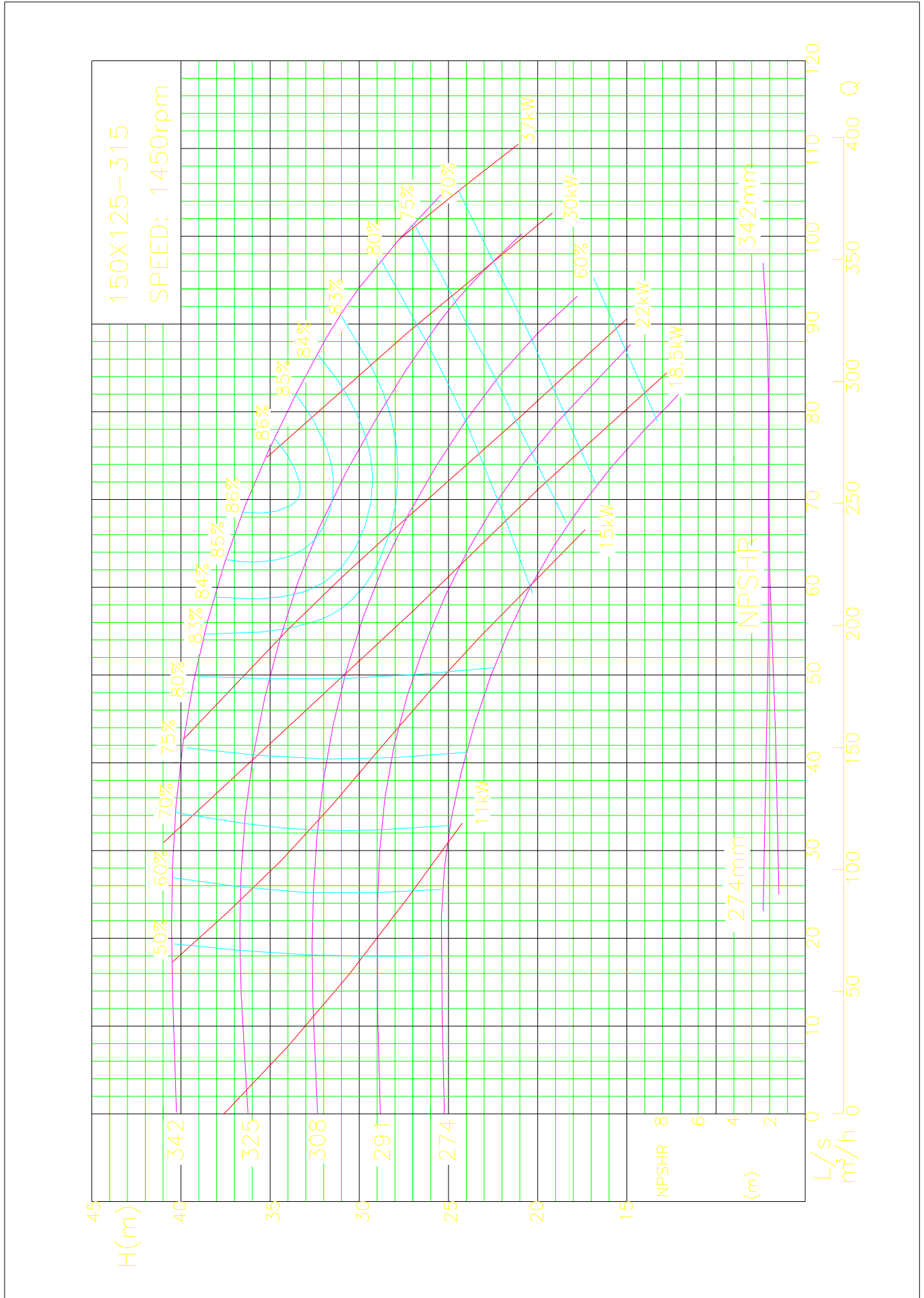

Performance Curves

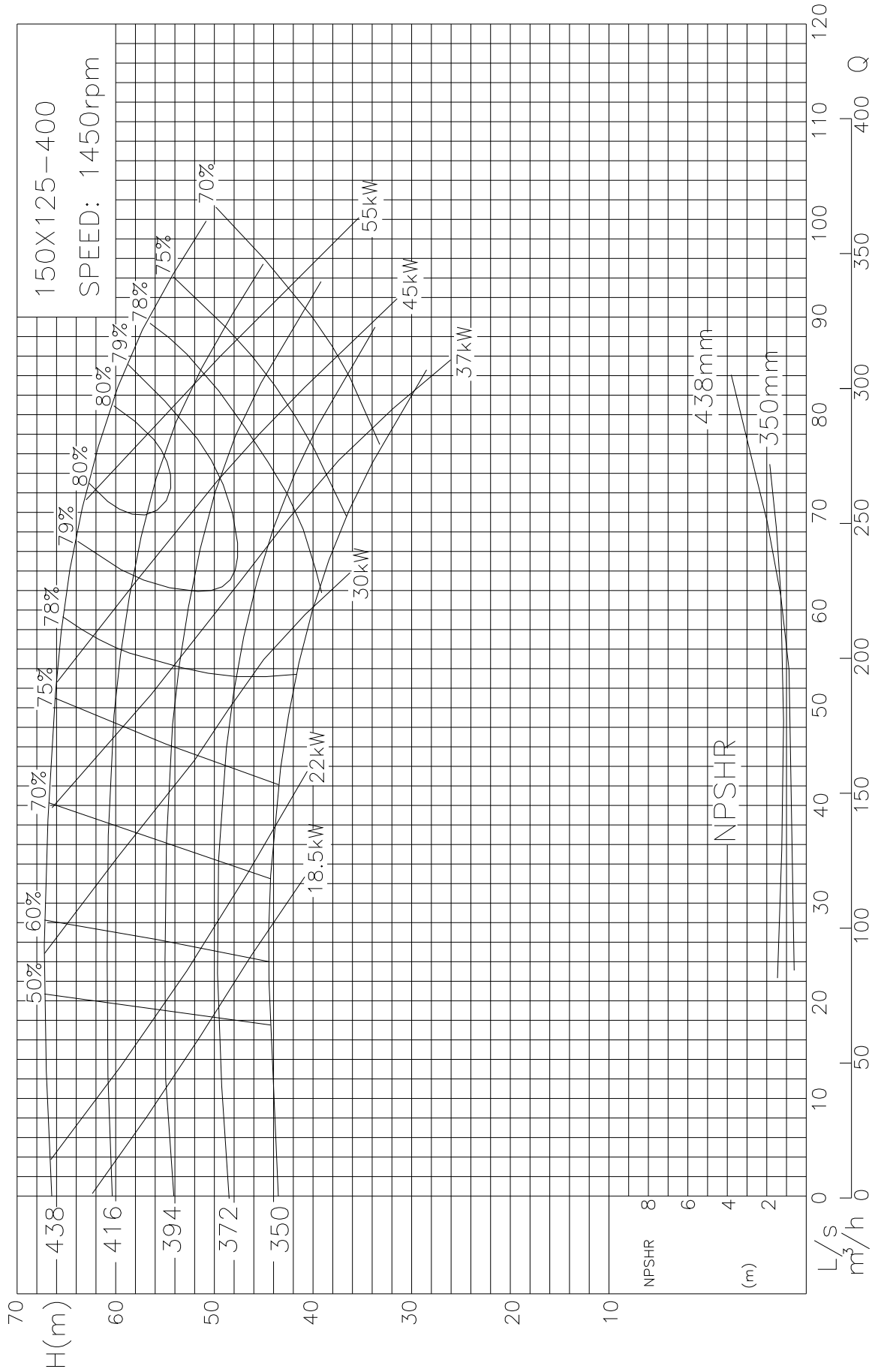

Performance Curves

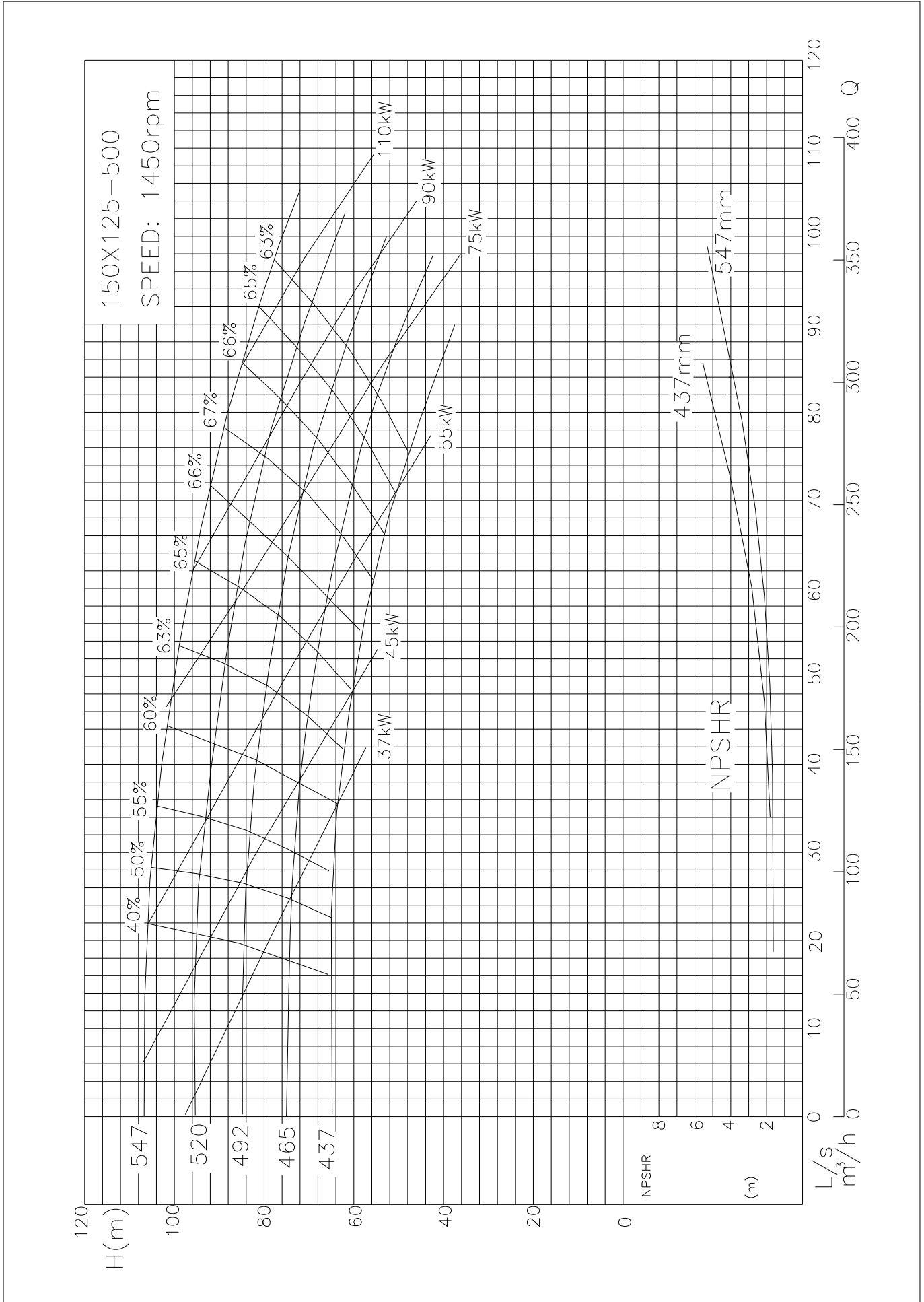



Performance Curves

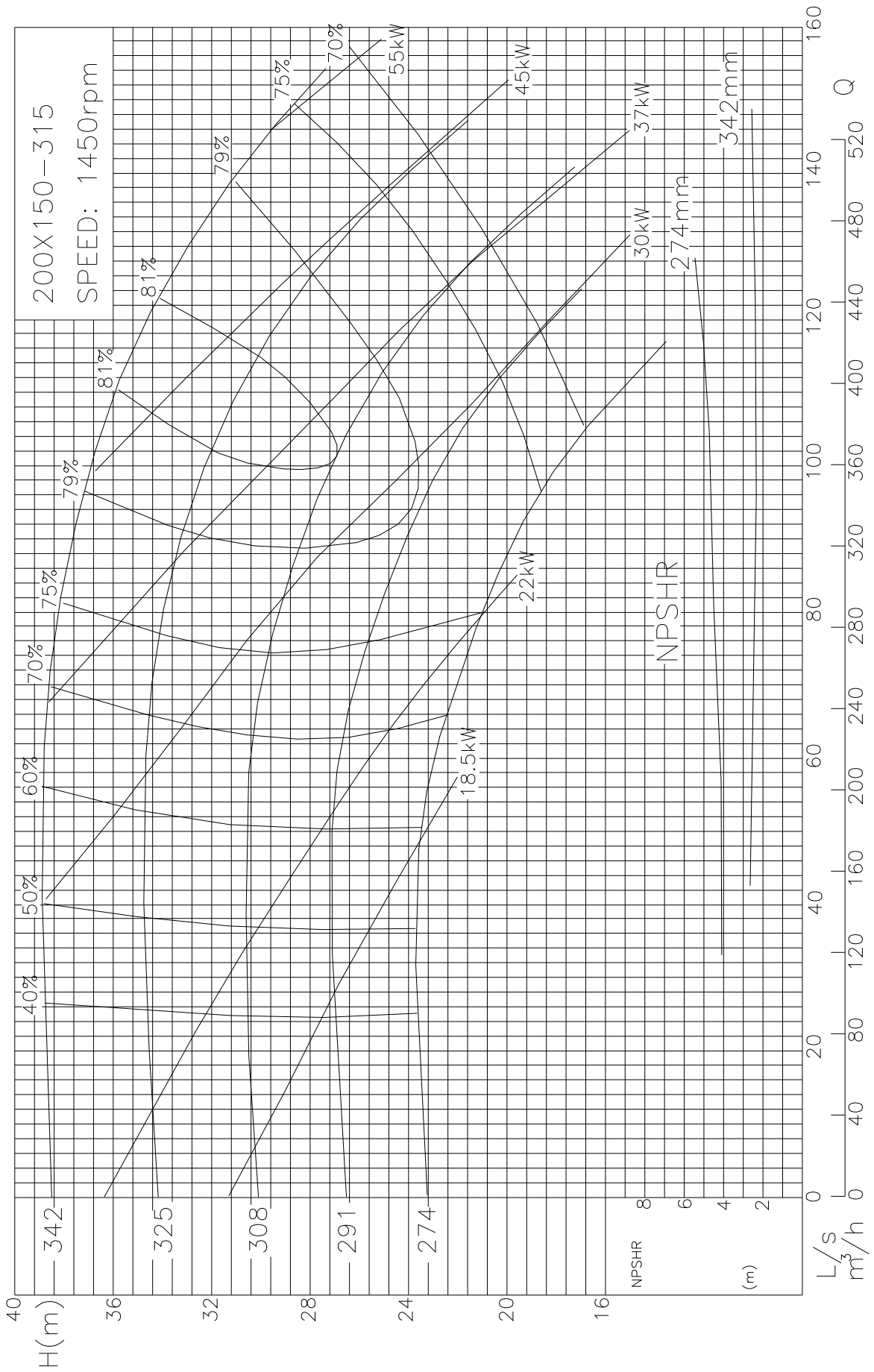

Performance Curves

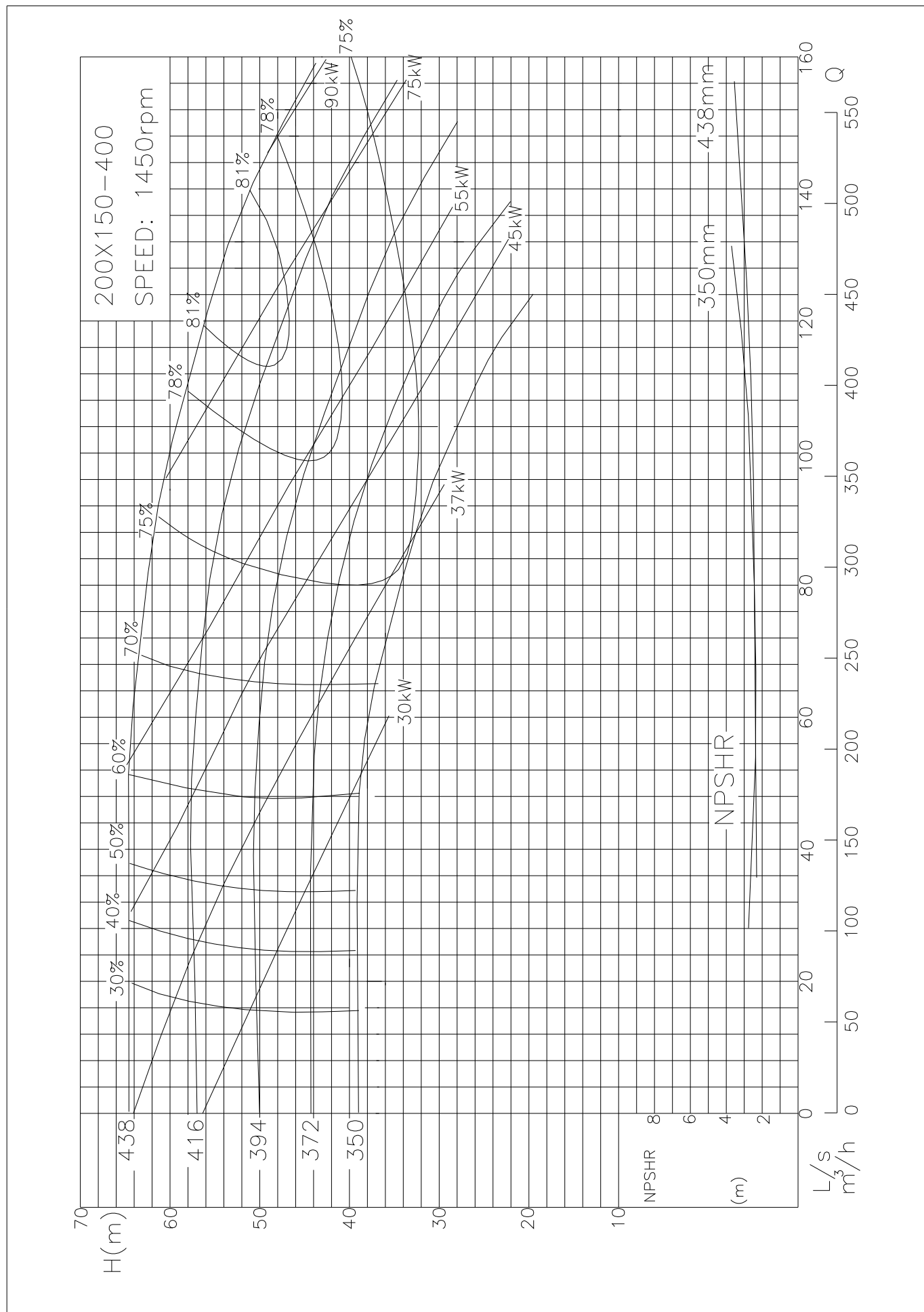

Performance Curves

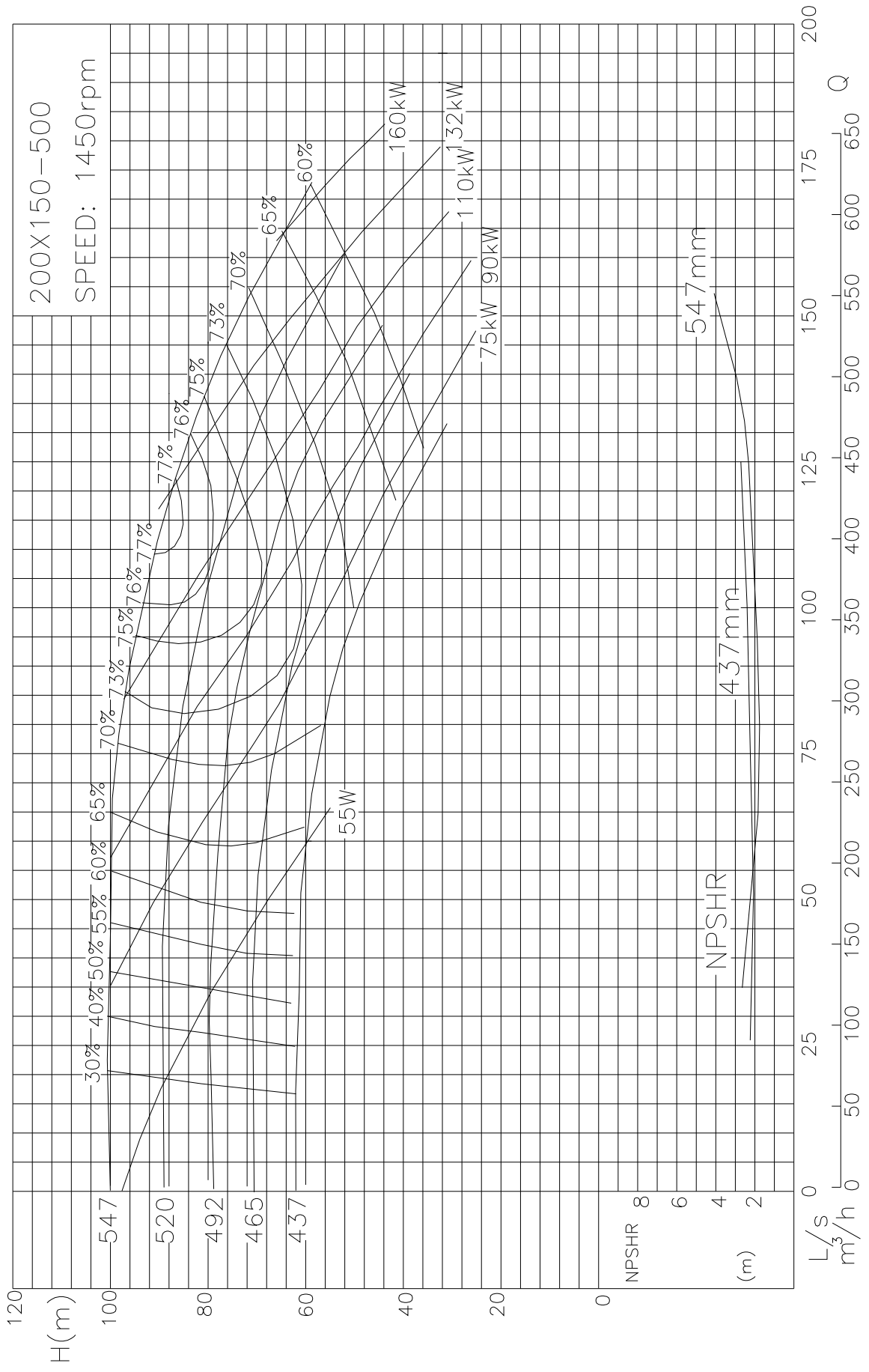

Performance Curves

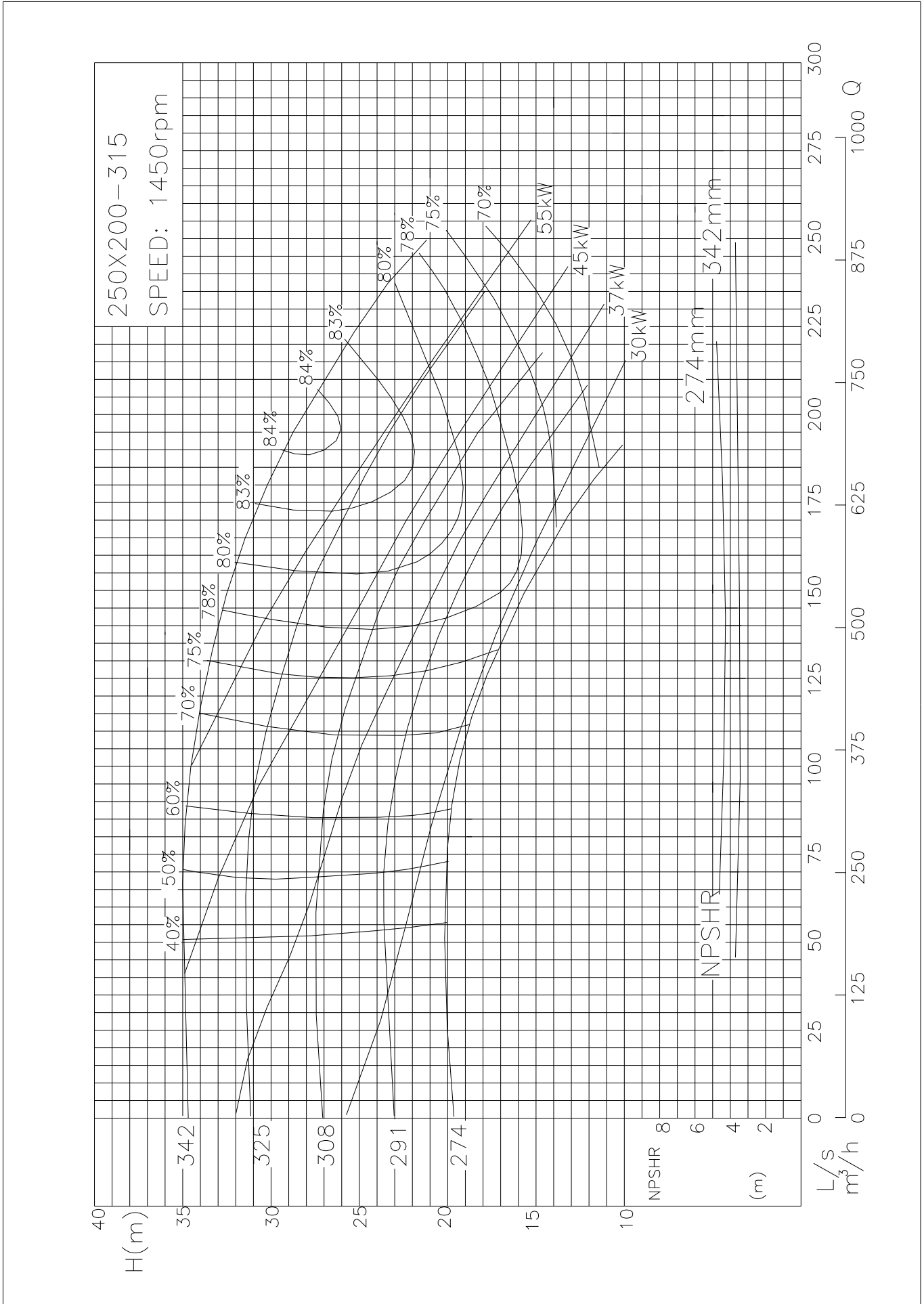

Performance Curves

